

Przebieg dróg gminnych ul. 3 Maja

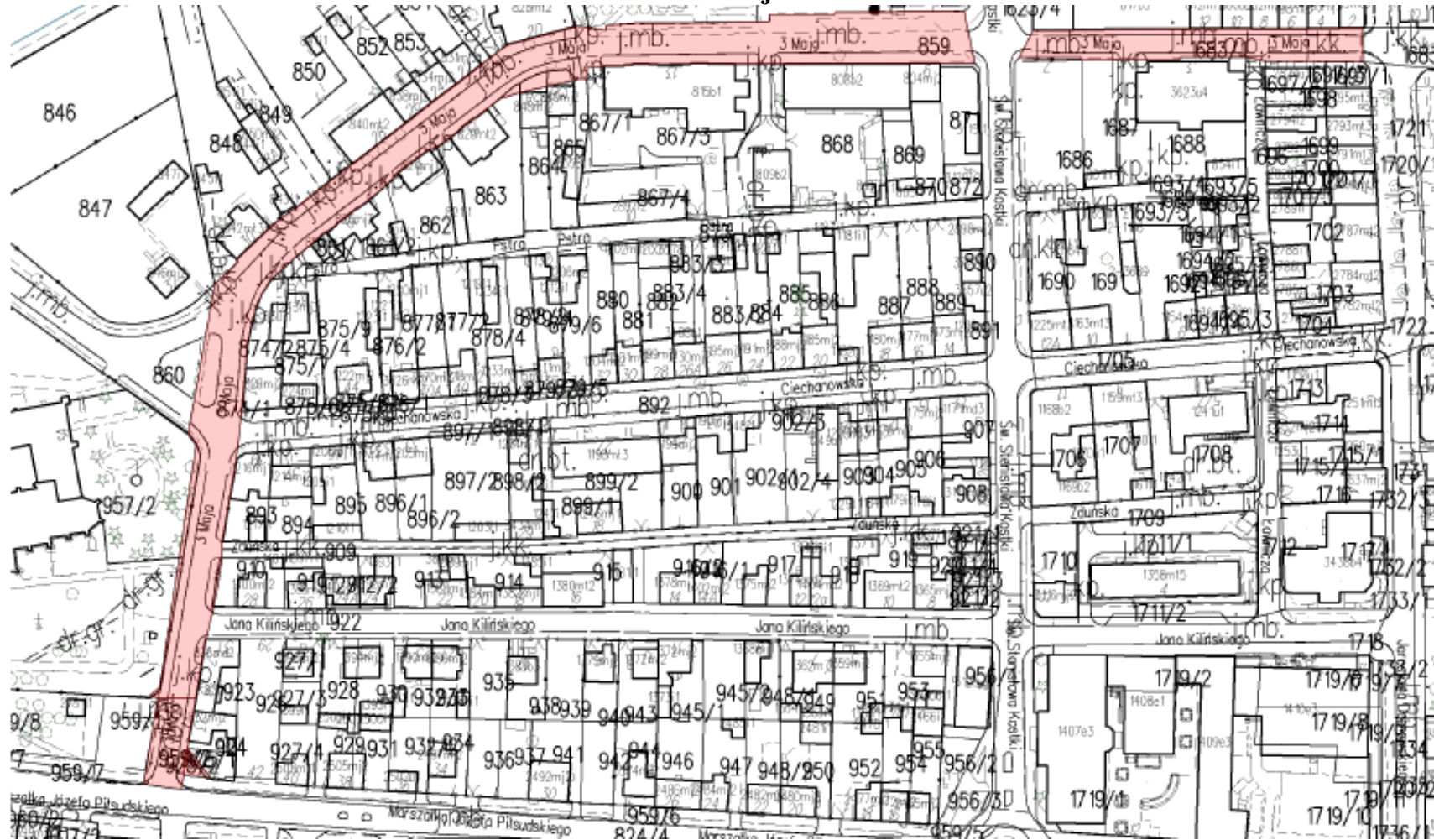



Legenda:

Skala 1 : 2 000

859 – numer działki

3 Maja – nazwa ulicy

-  - kontury działki
-  - przebieg drogi

ul. Al. Jana Pawła II (część 1)

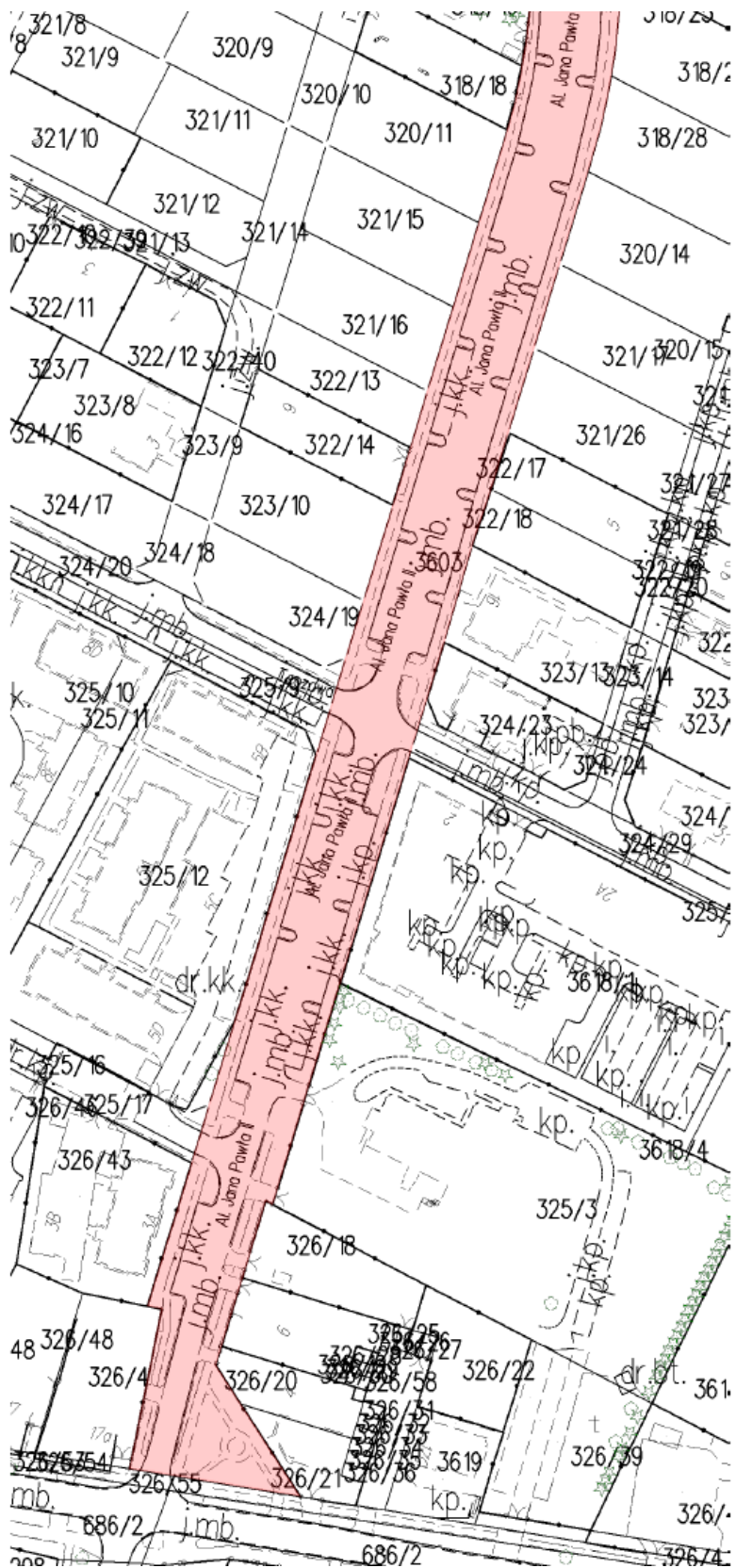

ul. Al. Jana Pawła II (część 2)

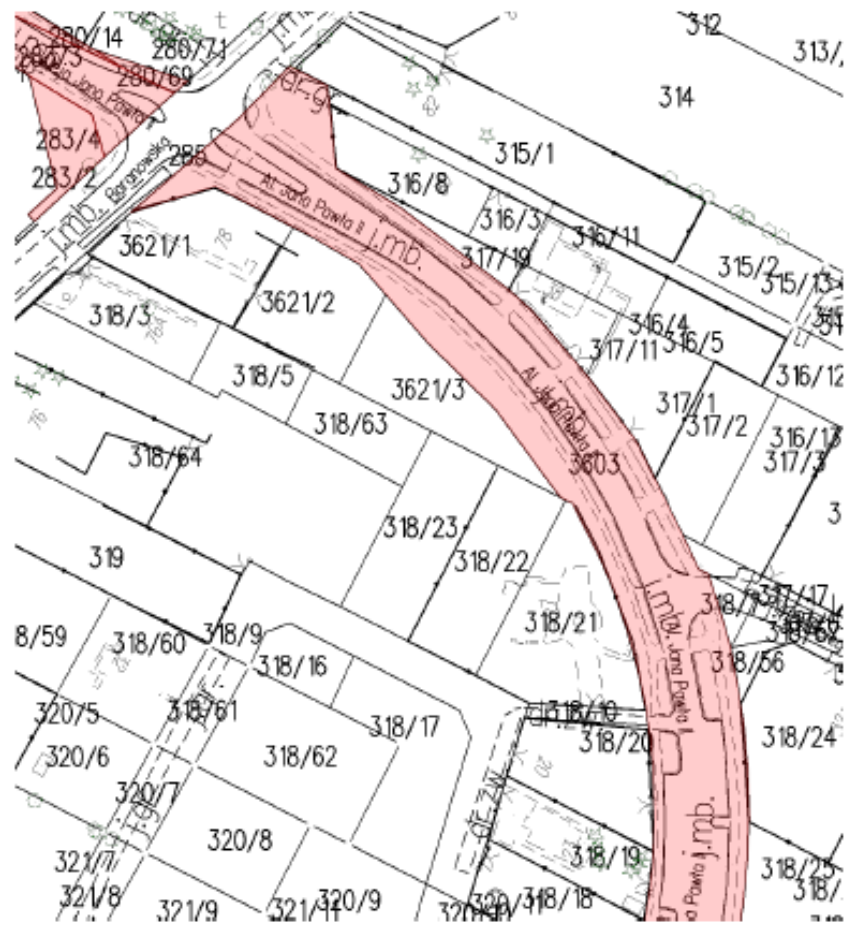

ul. Al. Jana Pawła II (część 3)



ul. Al. Wojska Polskiego (część 1)

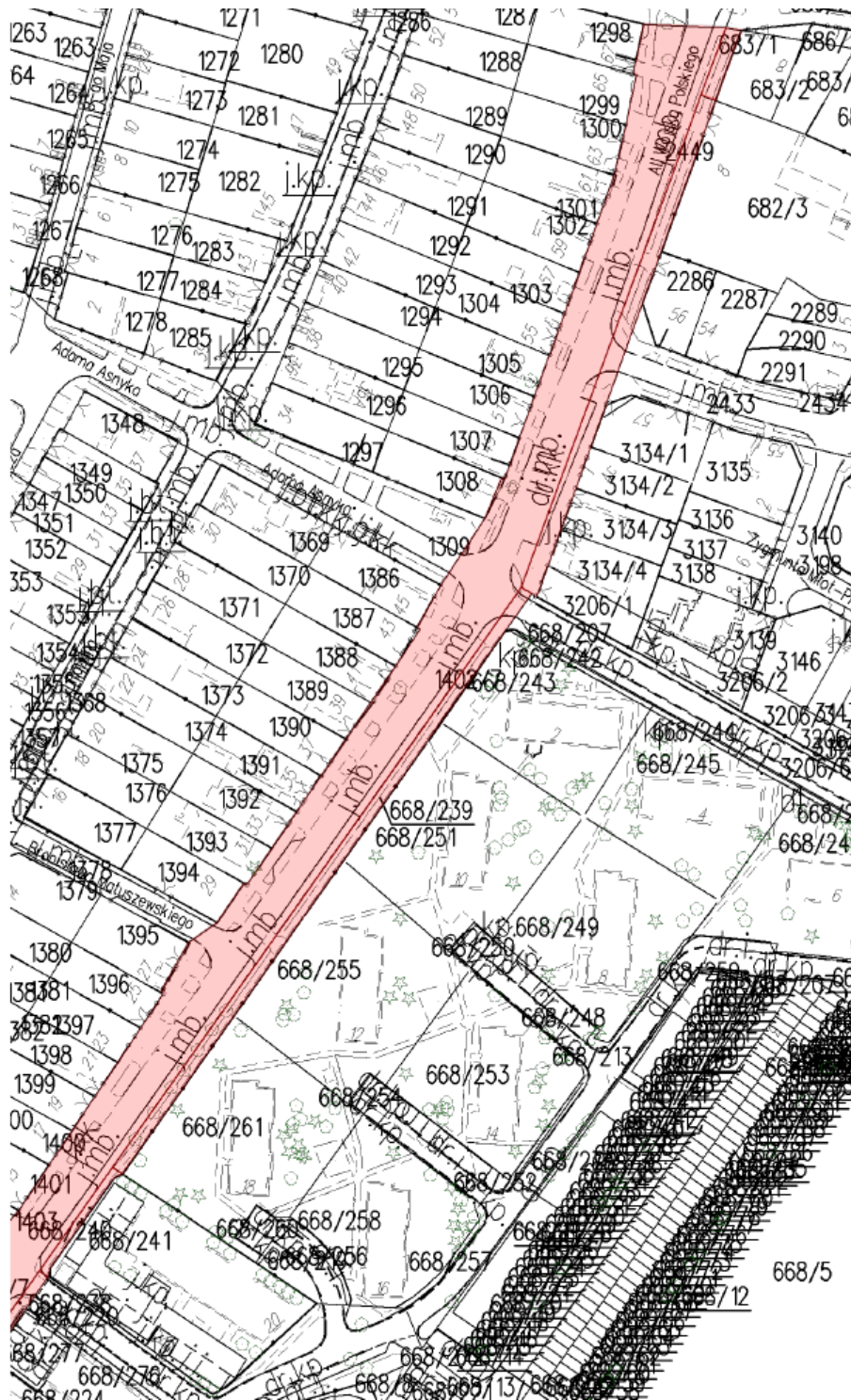

ul. Al. Wojska Polskiego (część 2)

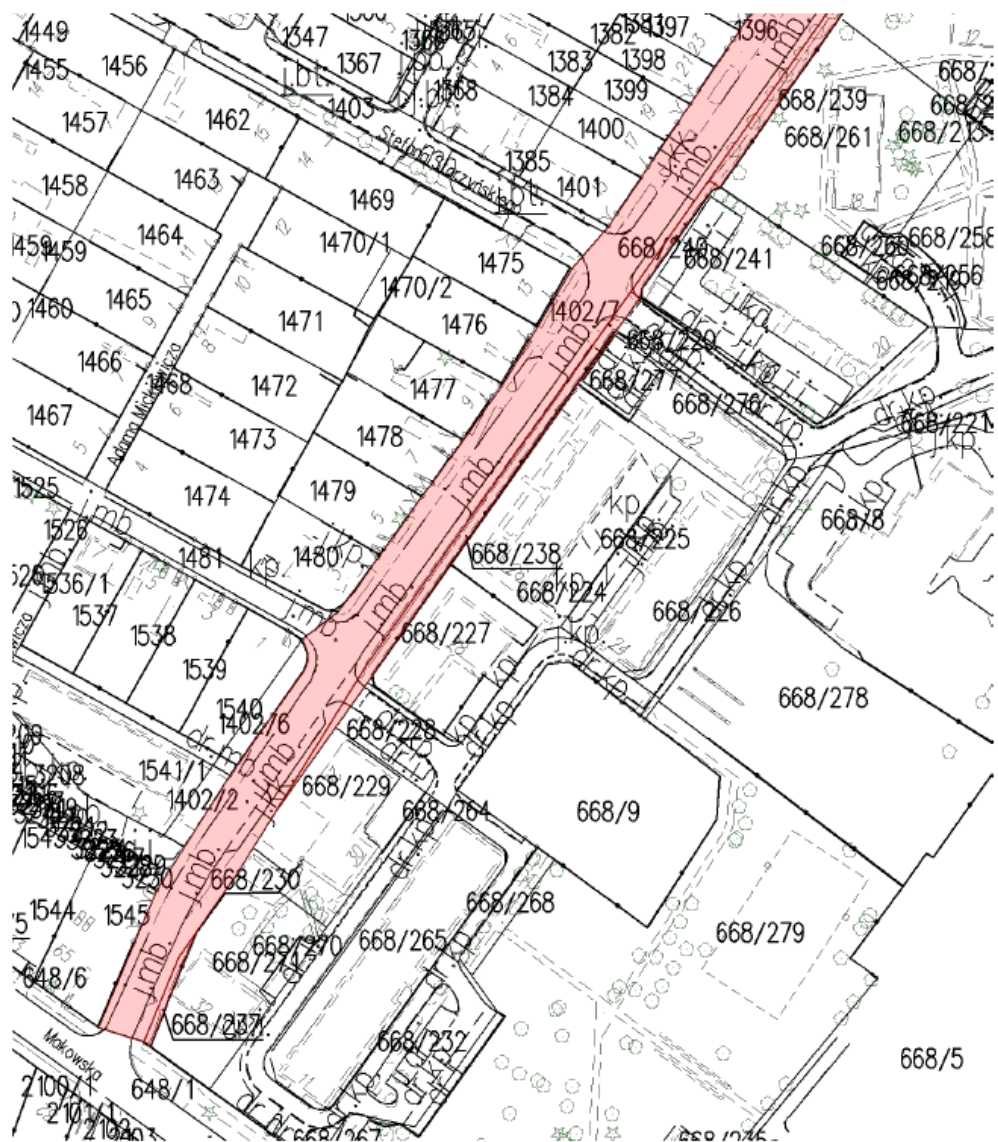

ul. Akacyjowa

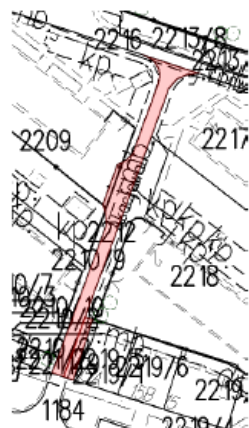

ul. Azaliowa

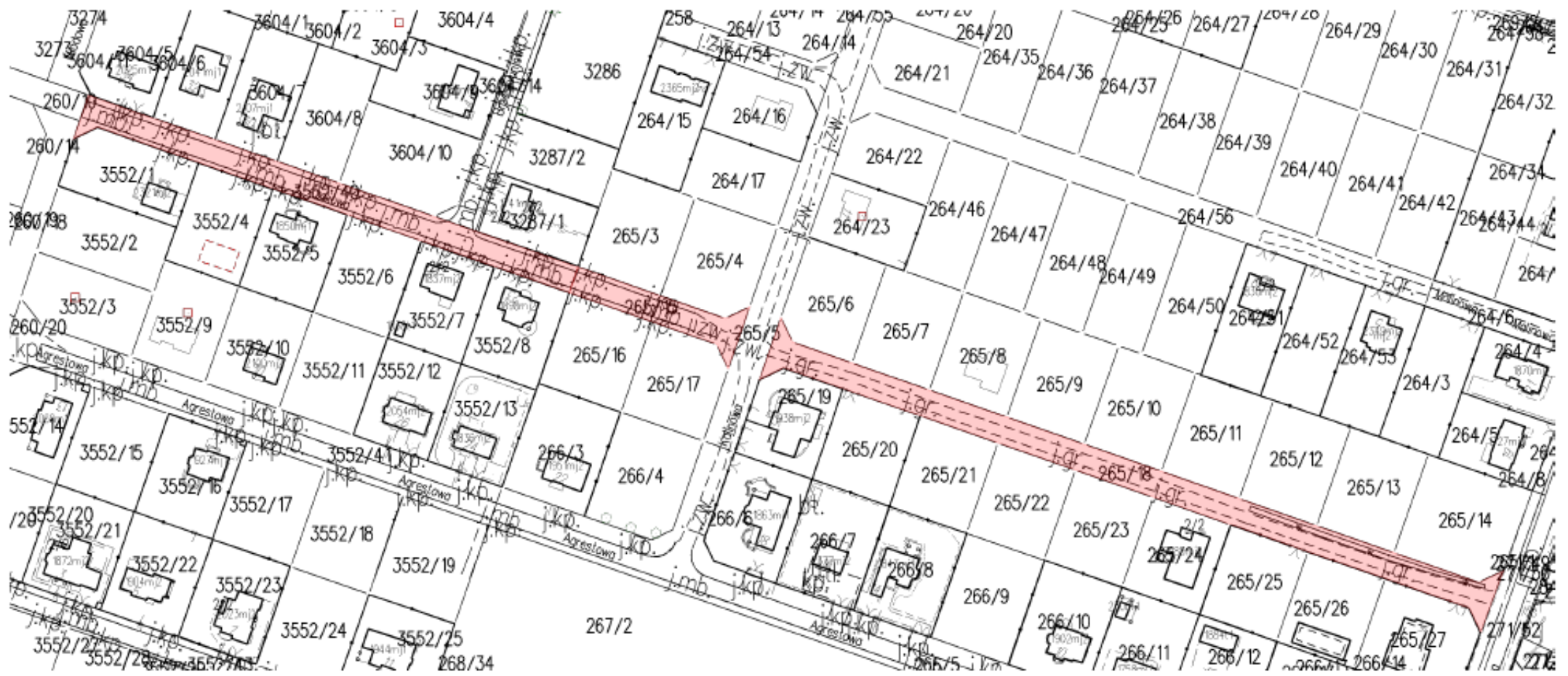

ul. Baczyńskiego Krzysztofa Kamila

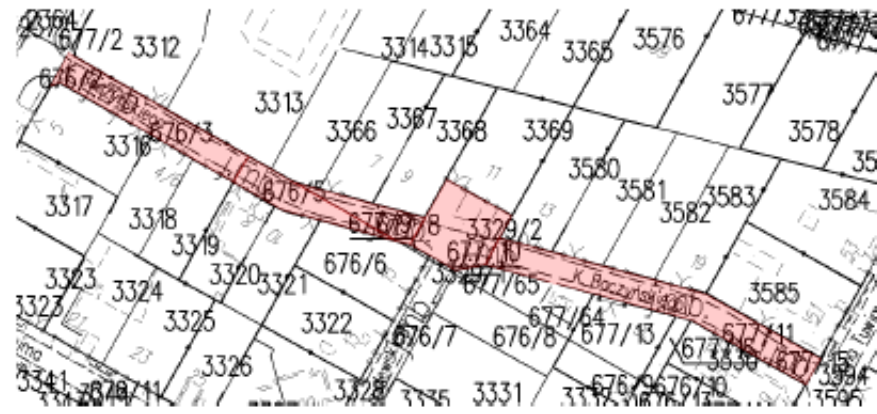

ul. Bienia Adama

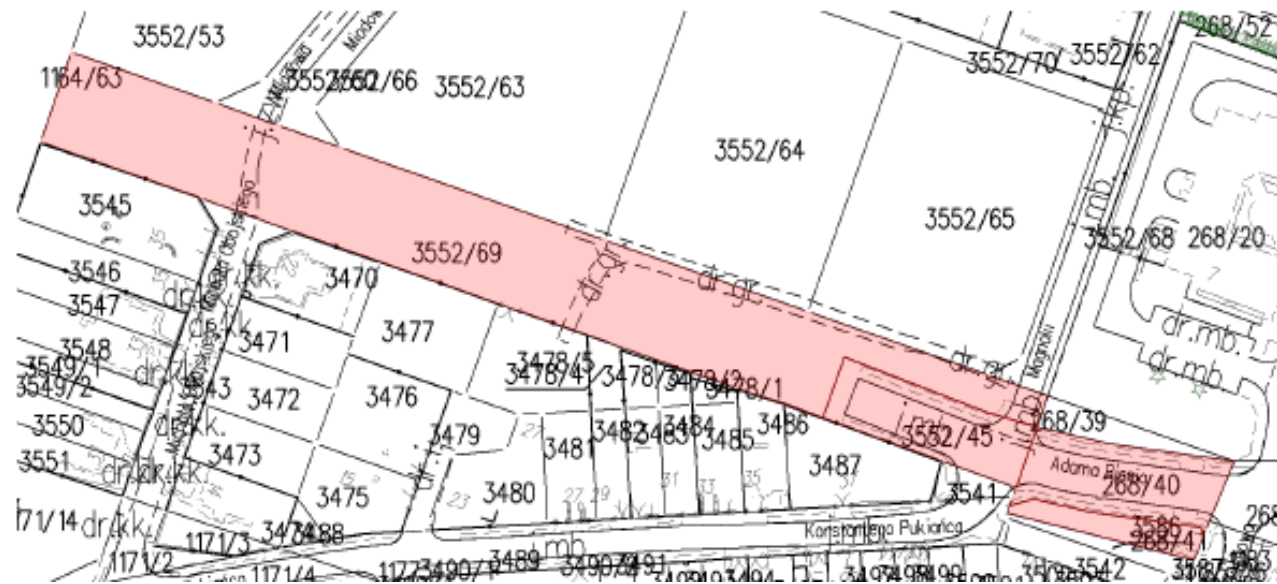

ul. Brzoskwiniowa

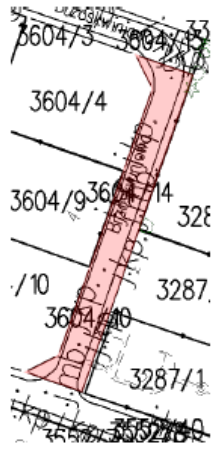

ul. Bukowa

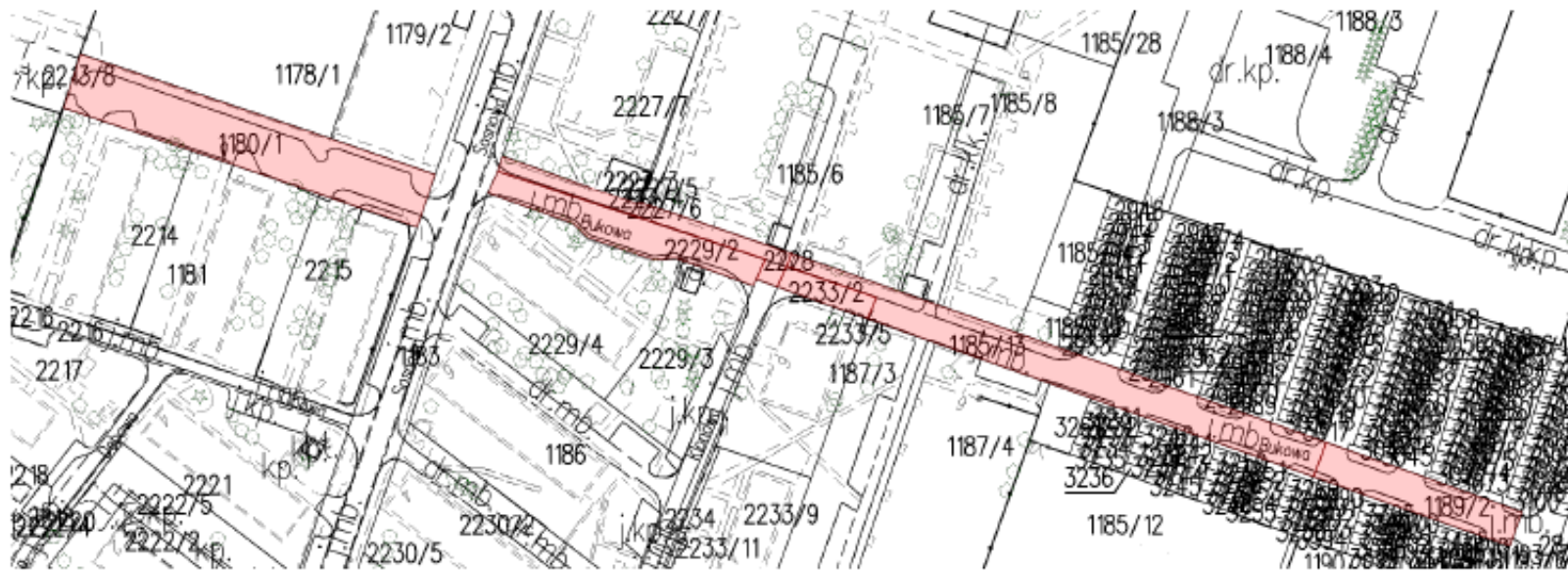

ul. Chabrowa

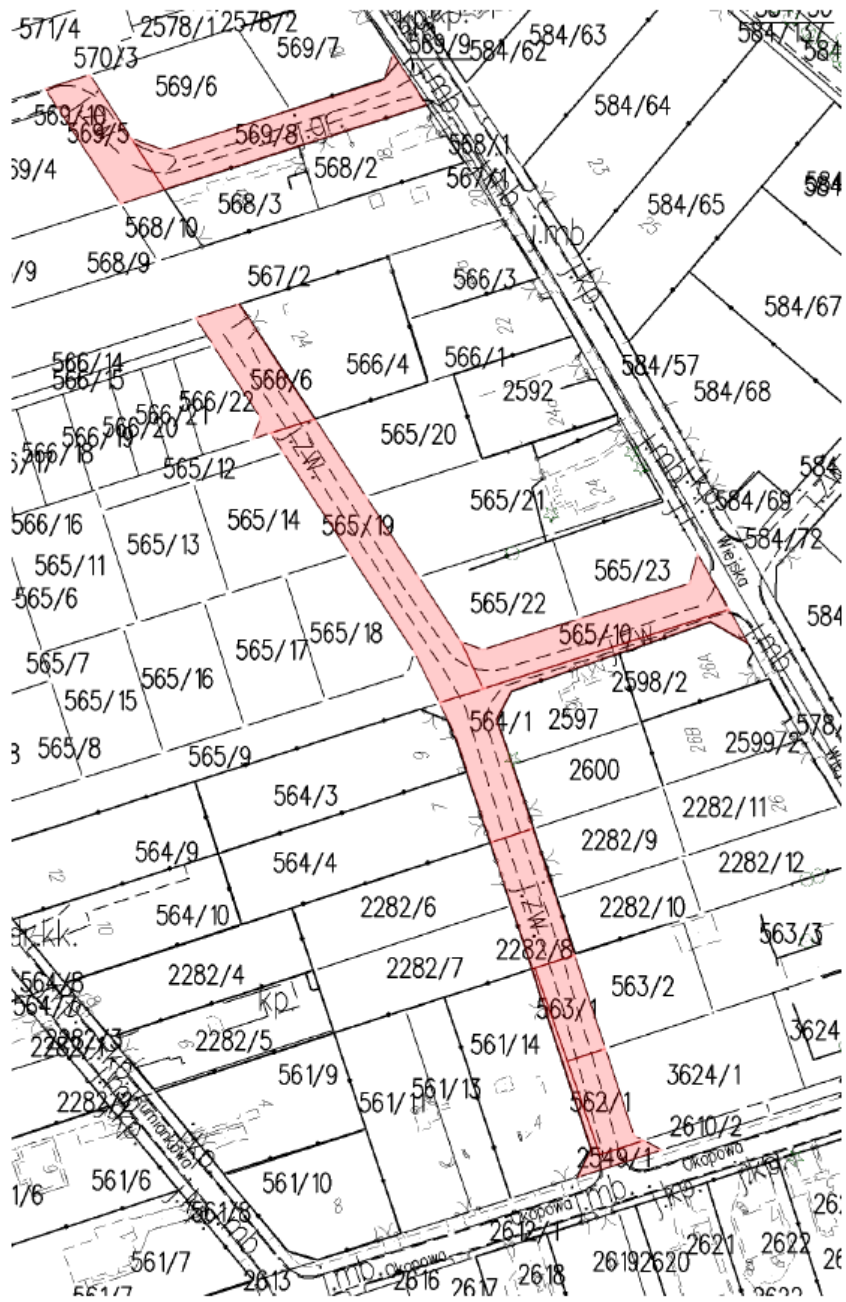

ul. Ciechanowska

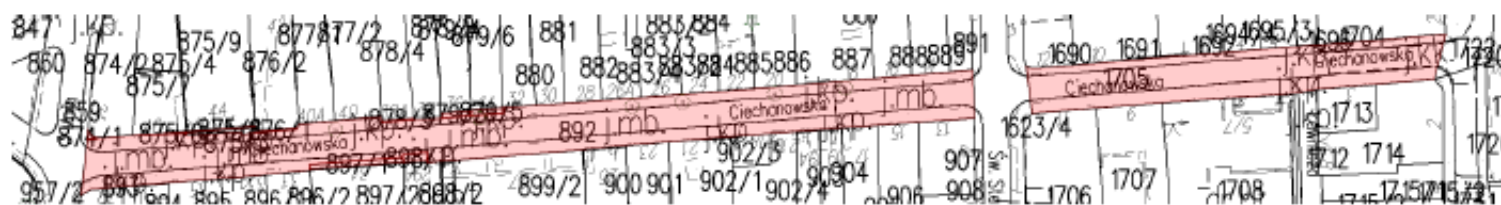

ul. Dąbrowskiego Jaroslawa

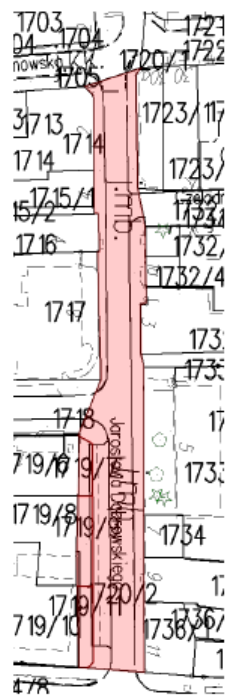

ul. Dębowa



ul. Dobra

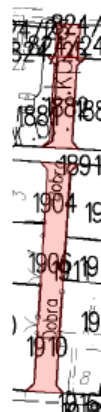

ul. Gdańska

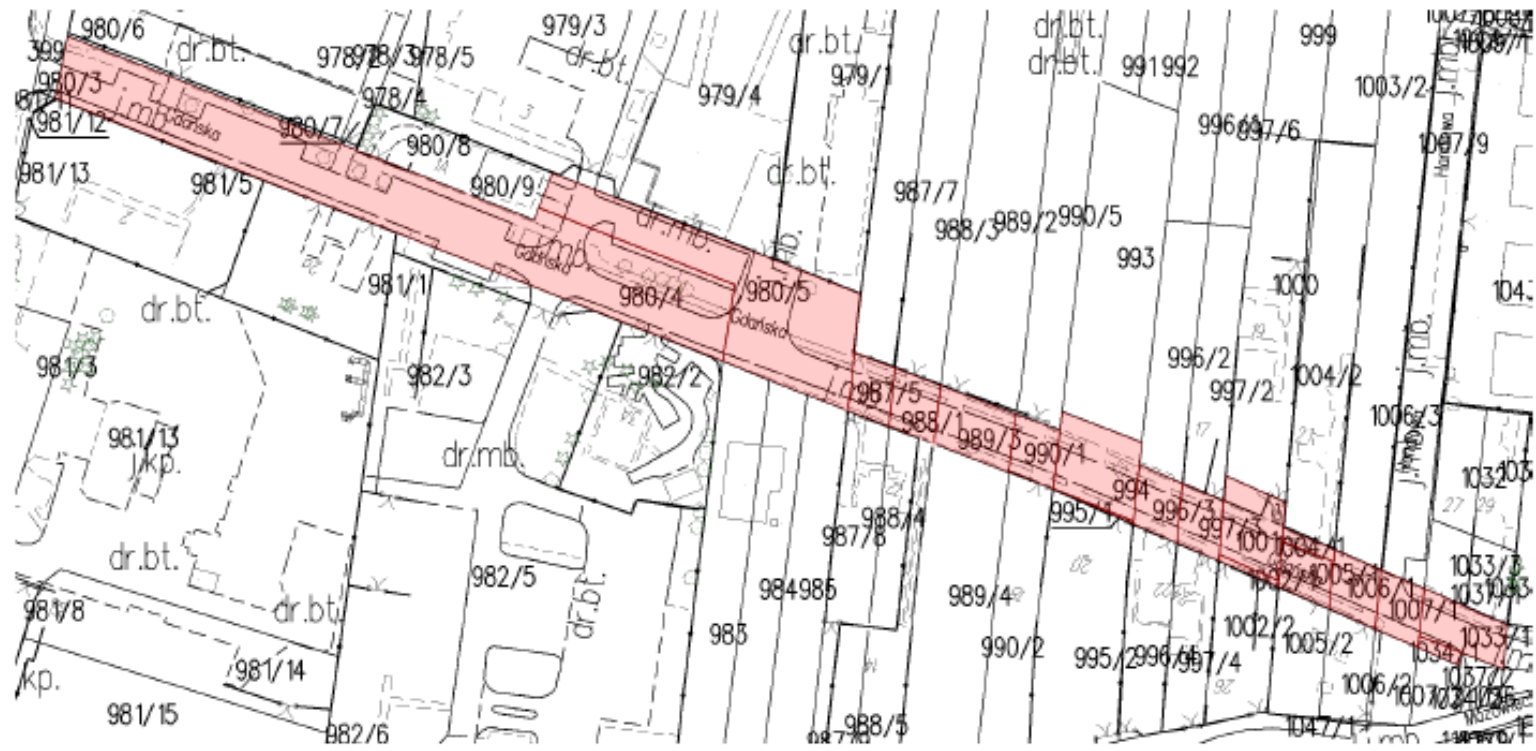

ul. Handlowa

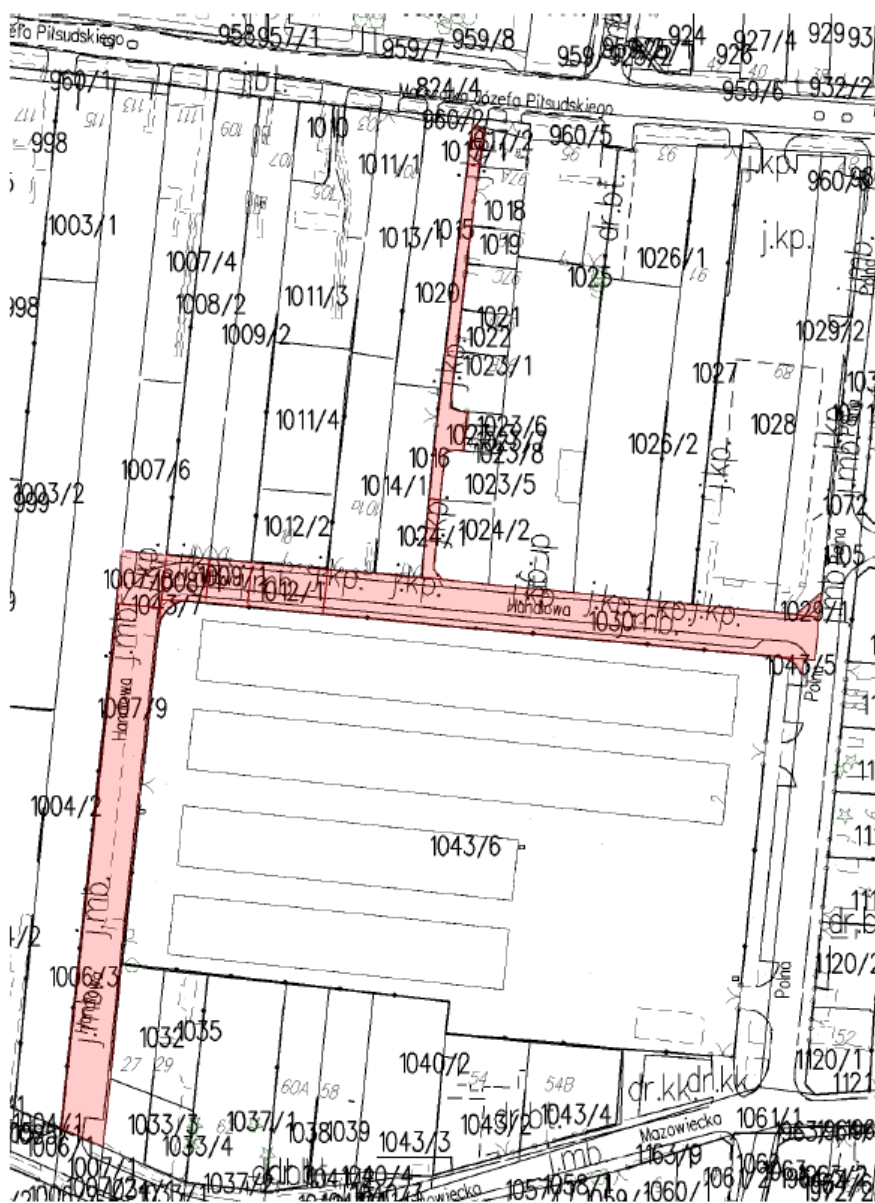

ul. Jelińskiego Stanisława

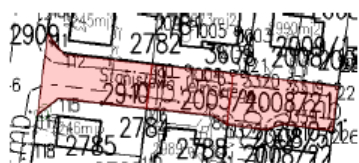

ul. Kalinowa

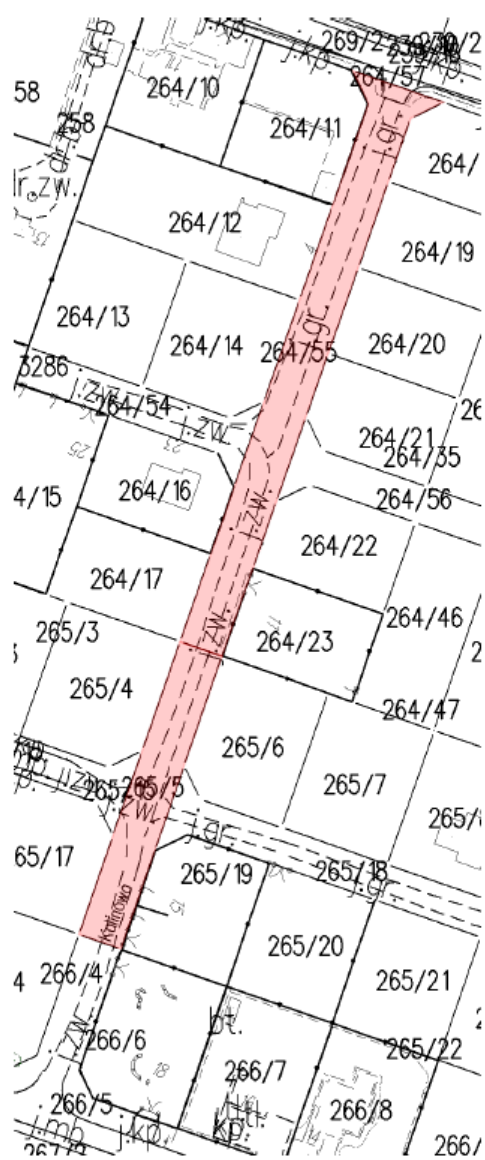

ul. Kardynała Stefana Wyszyńskiego

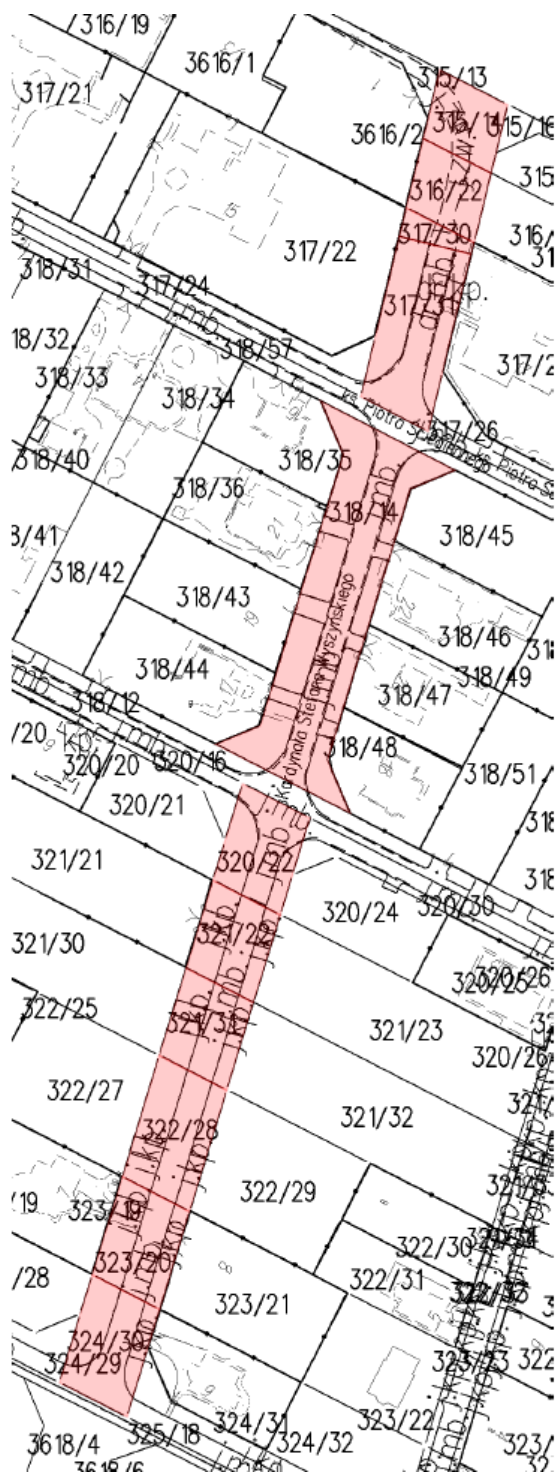

ul. Kilińskiego Jana

The drawing shows a street layout with a central horizontal street highlighted in red. The street is labeled 'Jana Kilińskiego' in several places. Handwritten annotations include 'mb.' and 'Jana Kilińskiego'. The drawing is annotated with numerous numerical identifiers and fractions.

910	911	129	12/2	913	914	915	916	916/1	917	918	919	920	921	922	923	924	925	926	927	928	929	930	931	932	933	934	935	936	937	938	939	940	941	942	943	944	945	946	947	948	949	950	951	952	953	954	955	956	957	958	959	960	961	962	963	964	965	966	967	968	969	970	971	972	973	974	975	976	977	978	979	980	981	982	983	984	985	986	987	988	989	990	991	992	993	994	995	996	997	998	999	1000
-----	-----	-----	------	-----	-----	-----	-----	-------	-----	-----	-----	-----	-----	-----	-----	-----	-----	-----	-----	-----	-----	-----	-----	-----	-----	-----	-----	-----	-----	-----	-----	-----	-----	-----	-----	-----	-----	-----	-----	-----	-----	-----	-----	-----	-----	-----	-----	-----	-----	-----	-----	-----	-----	-----	-----	-----	-----	-----	-----	-----	-----	-----	-----	-----	-----	-----	-----	-----	-----	-----	-----	-----	-----	-----	-----	-----	-----	-----	-----	-----	-----	-----	-----	-----	-----	-----	-----	-----	-----	-----	-----	------

ul. Kolejowa (część 1)

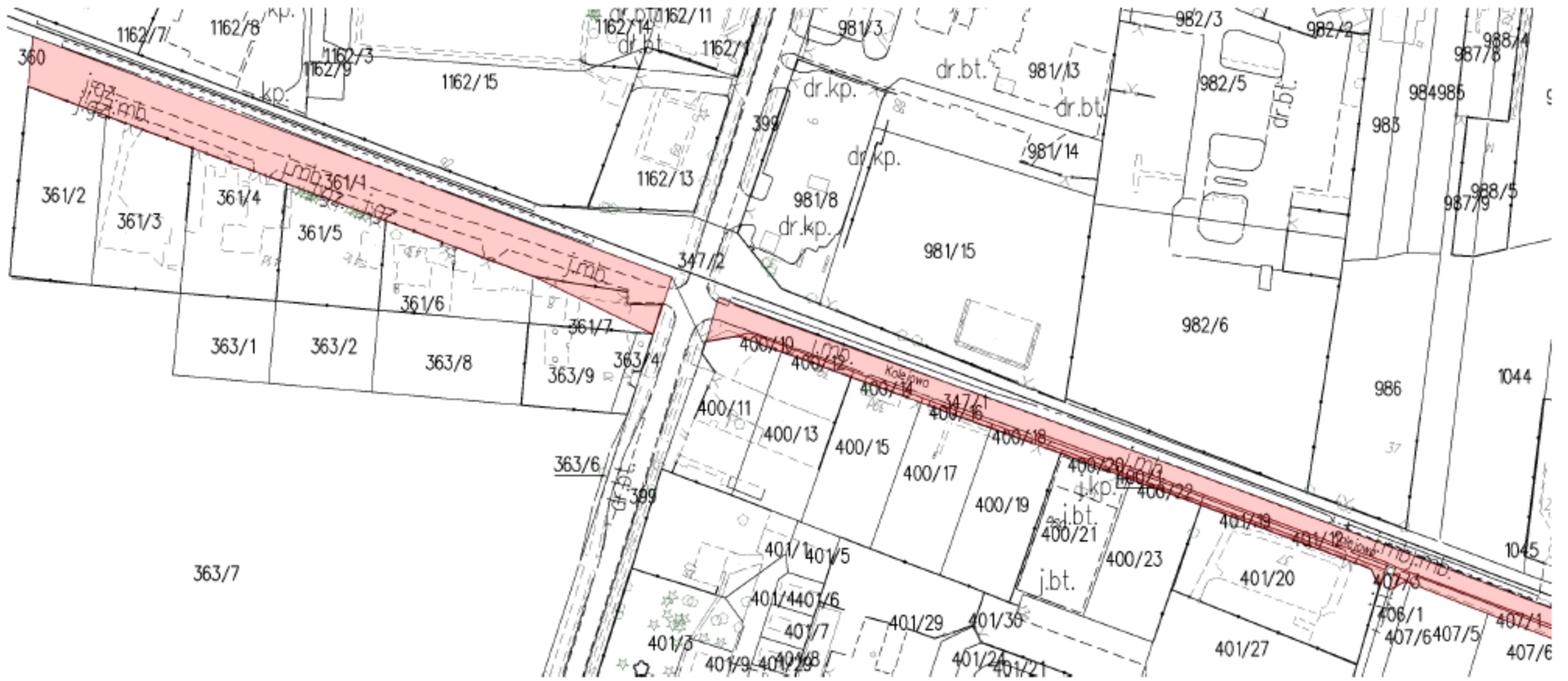

ul. Kolejowa (część 2)



ul. Kolejowa (część 3)

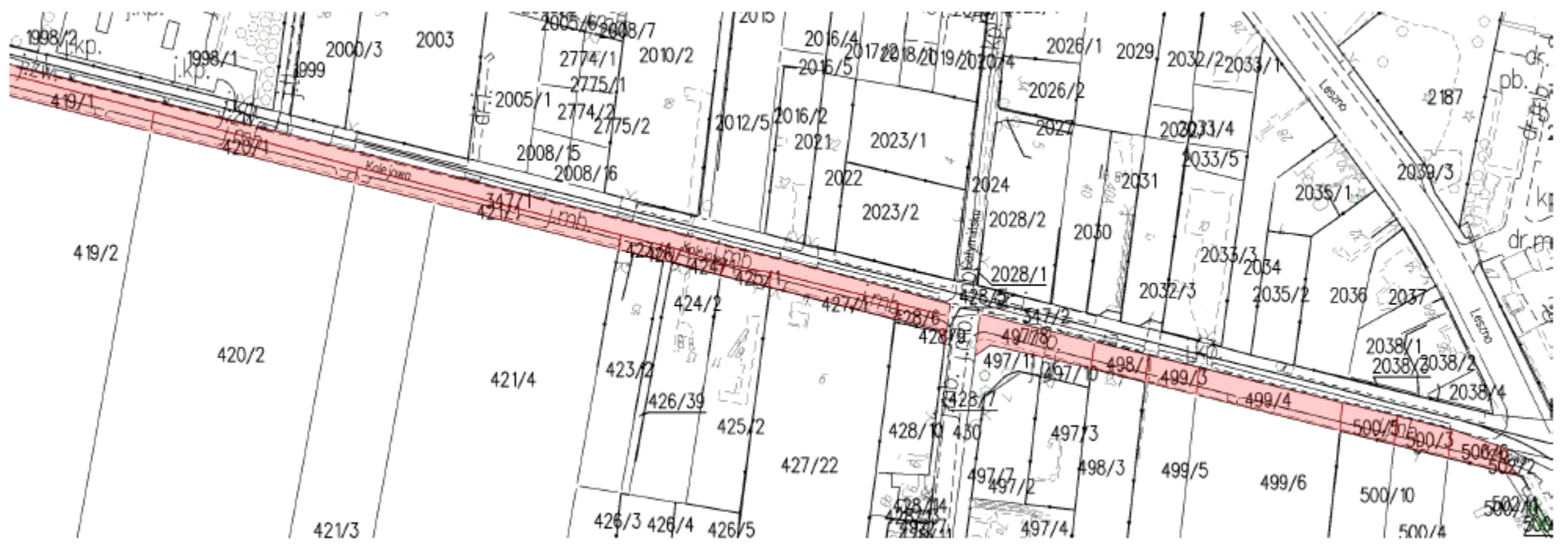

ul. Królowej Jadwigi

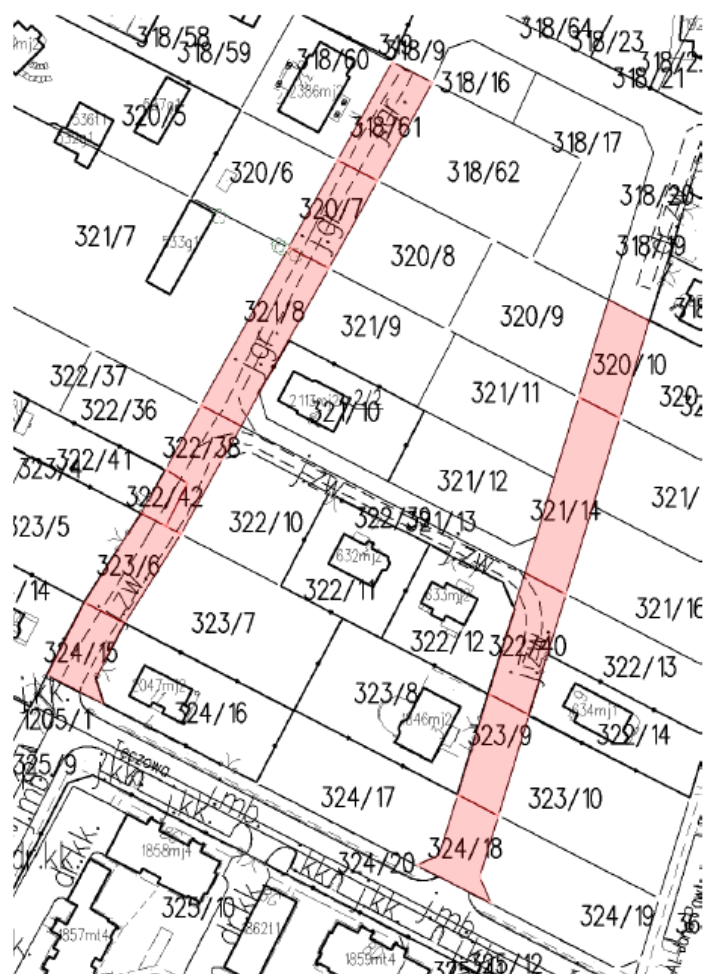

ul. ks. Piotra Skargi

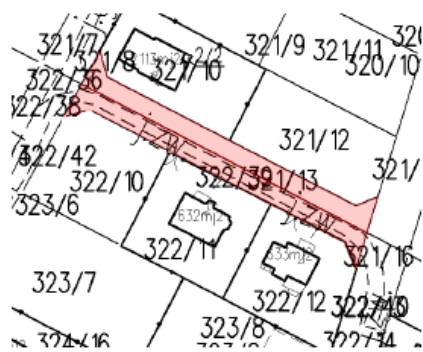

ul. ks. Piotra Ściegiennego

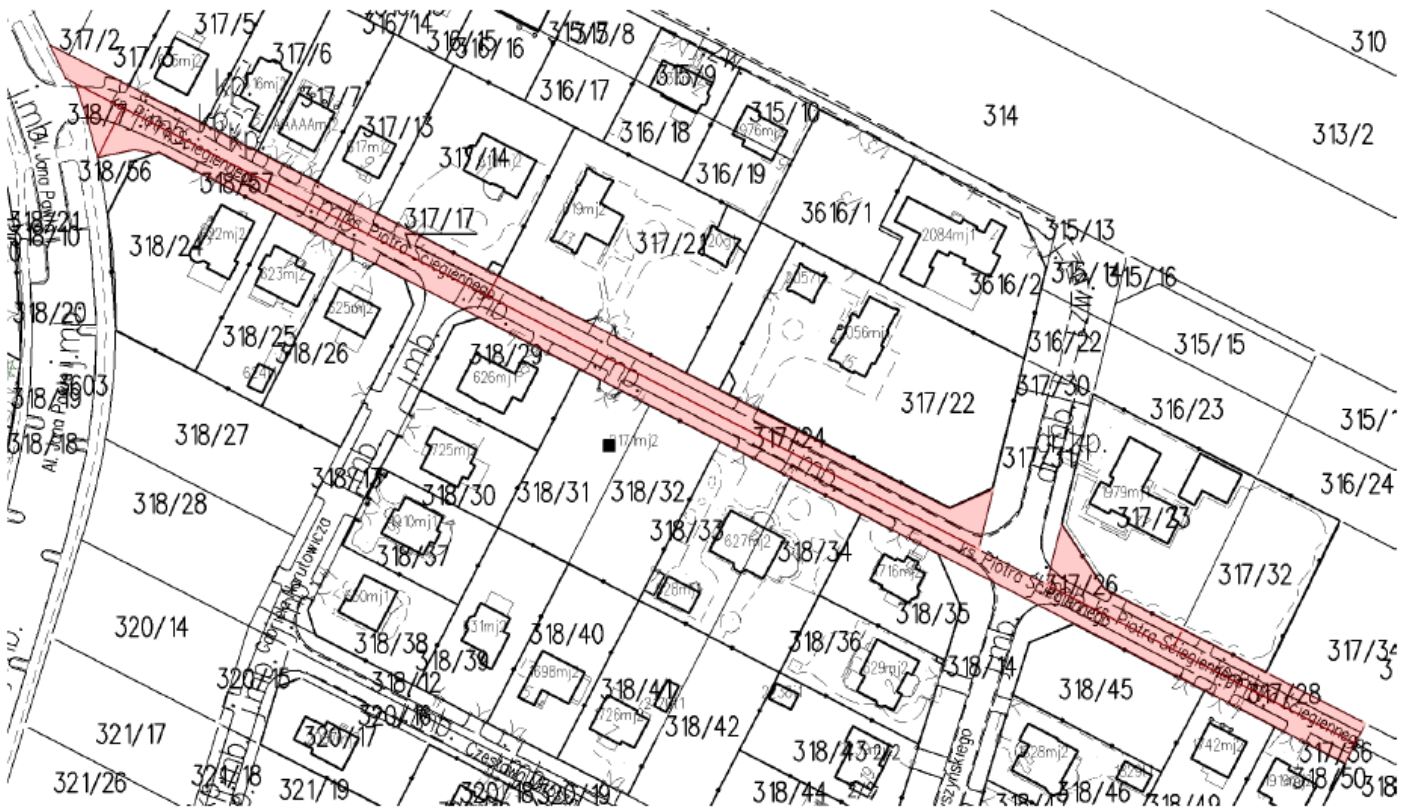

ul. Księża Janusza

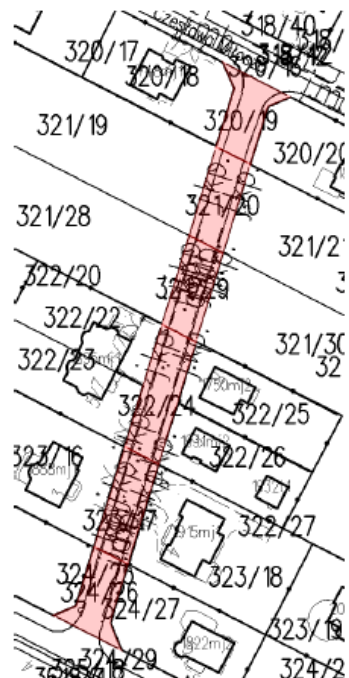

ul. Kurpiowska



ul. Leszczynowa

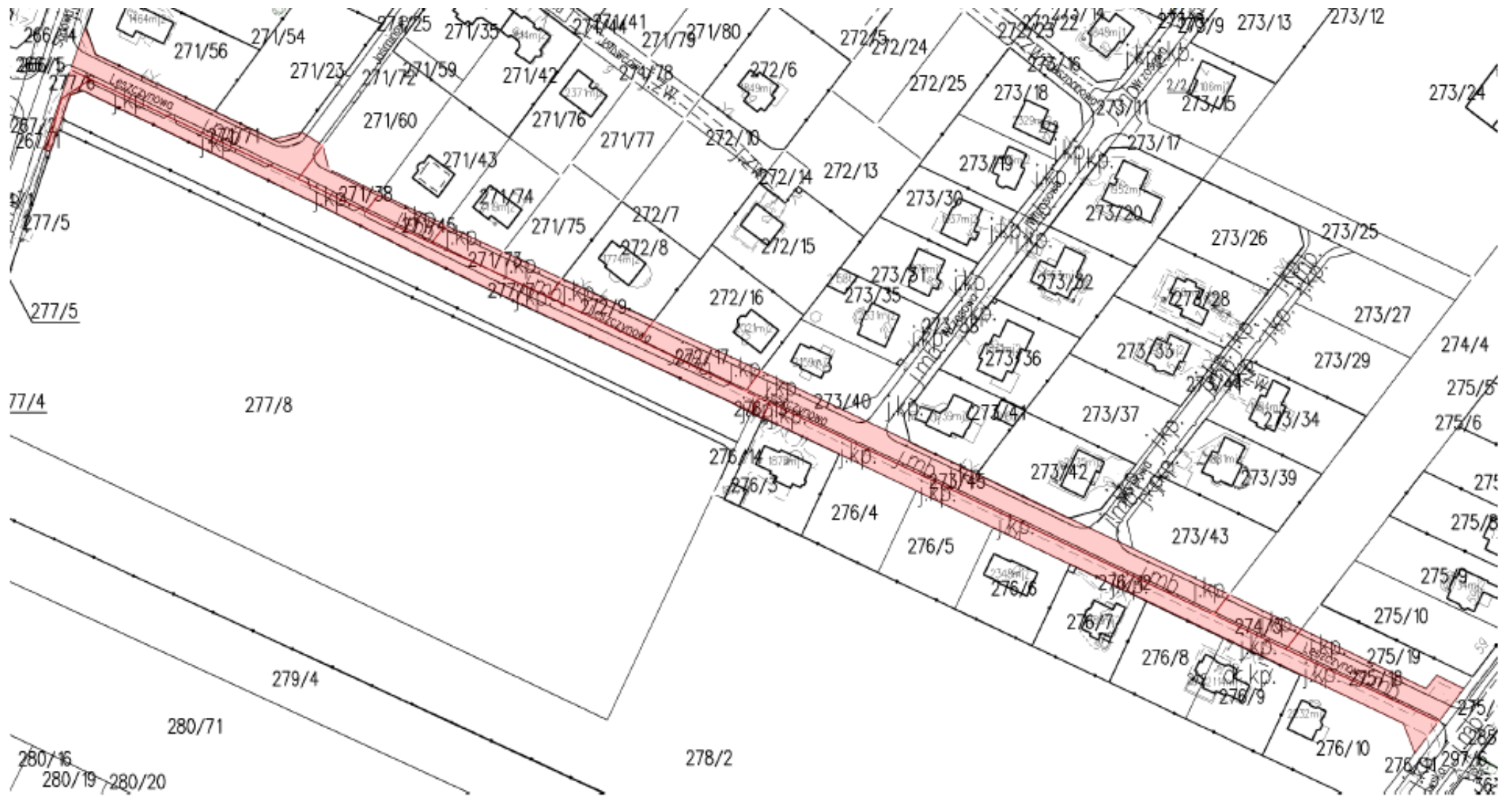

ul. Lipowa



ul. Łąkowa

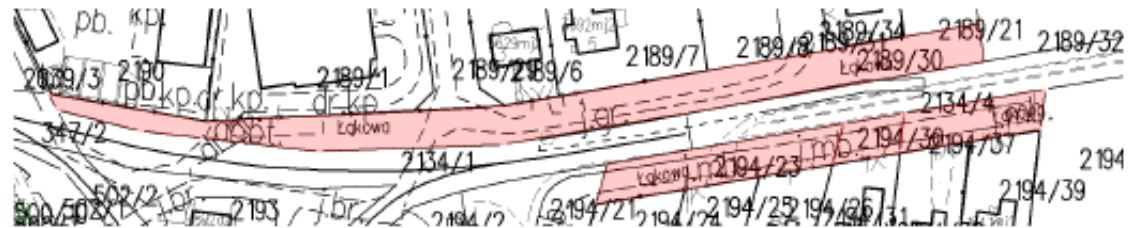

ul. Malinowa

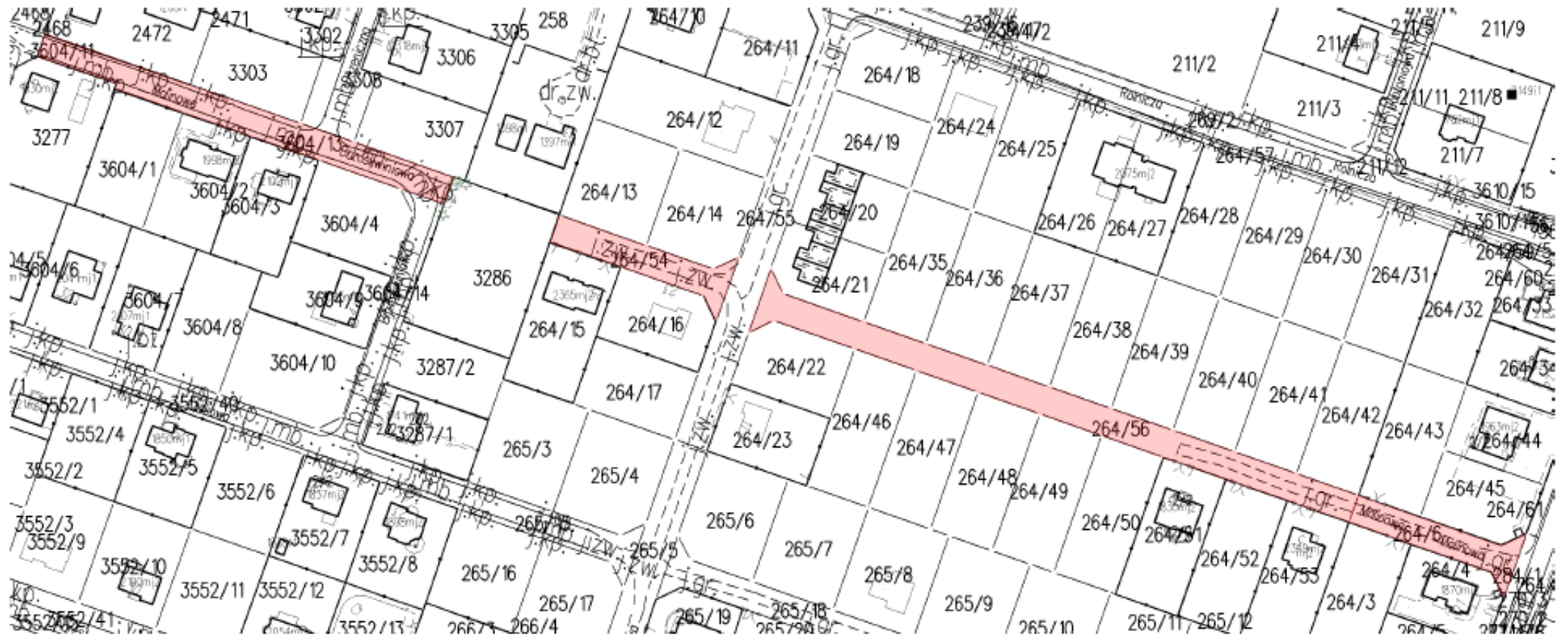

ul. Mazowiecka (część 1)



ul. Mazowiecka (część 2)

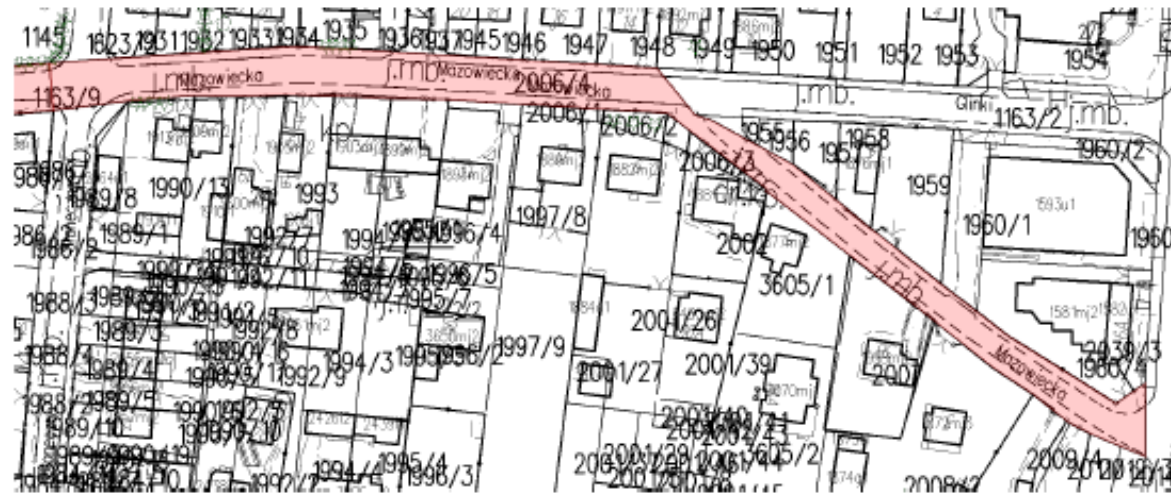

ul. Miła

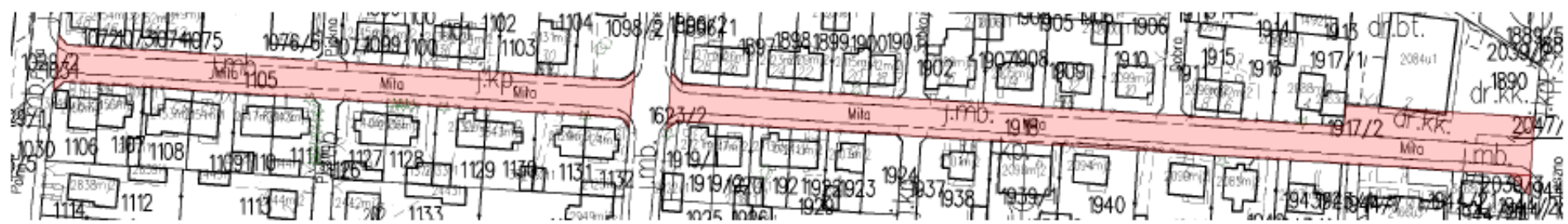

ul. Miłozza Czesława

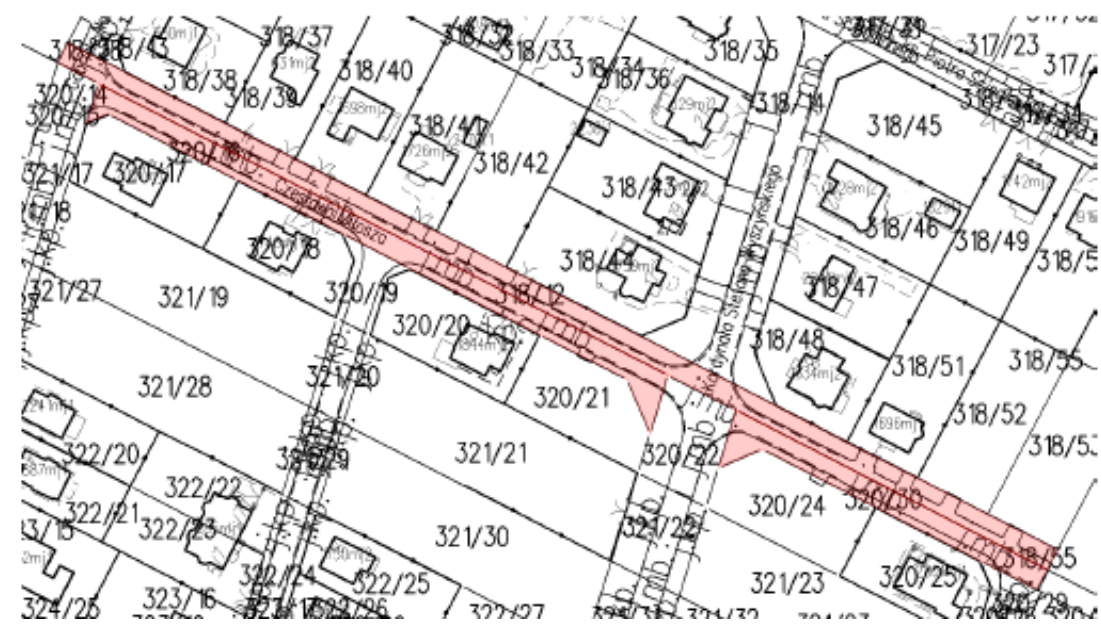

ul. Miodowa (część 1)

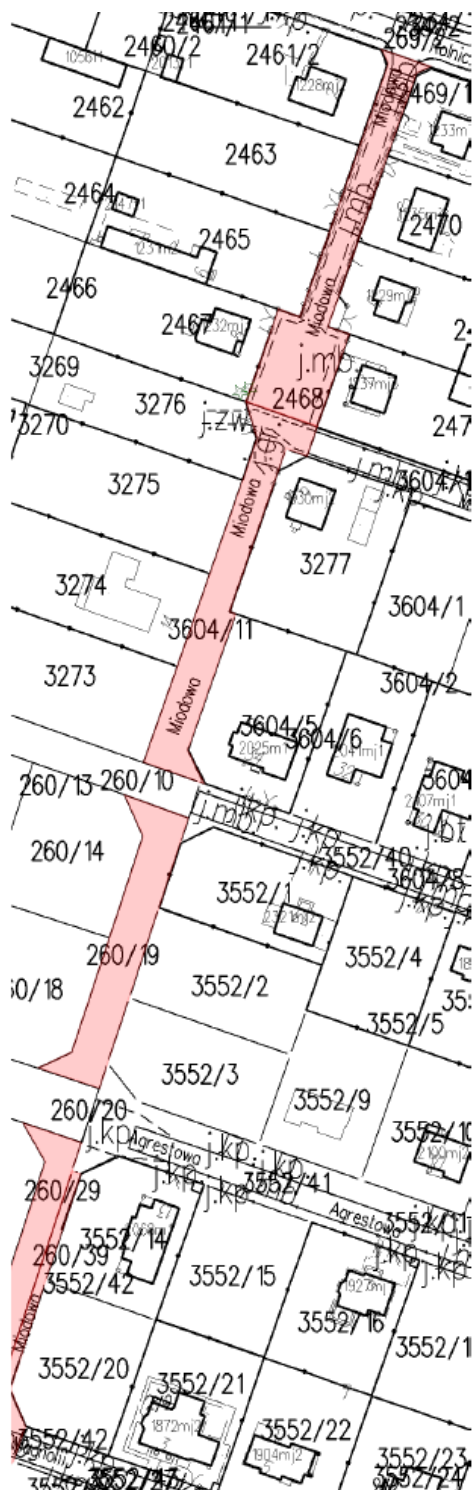

ul. Miodowa (część 2)

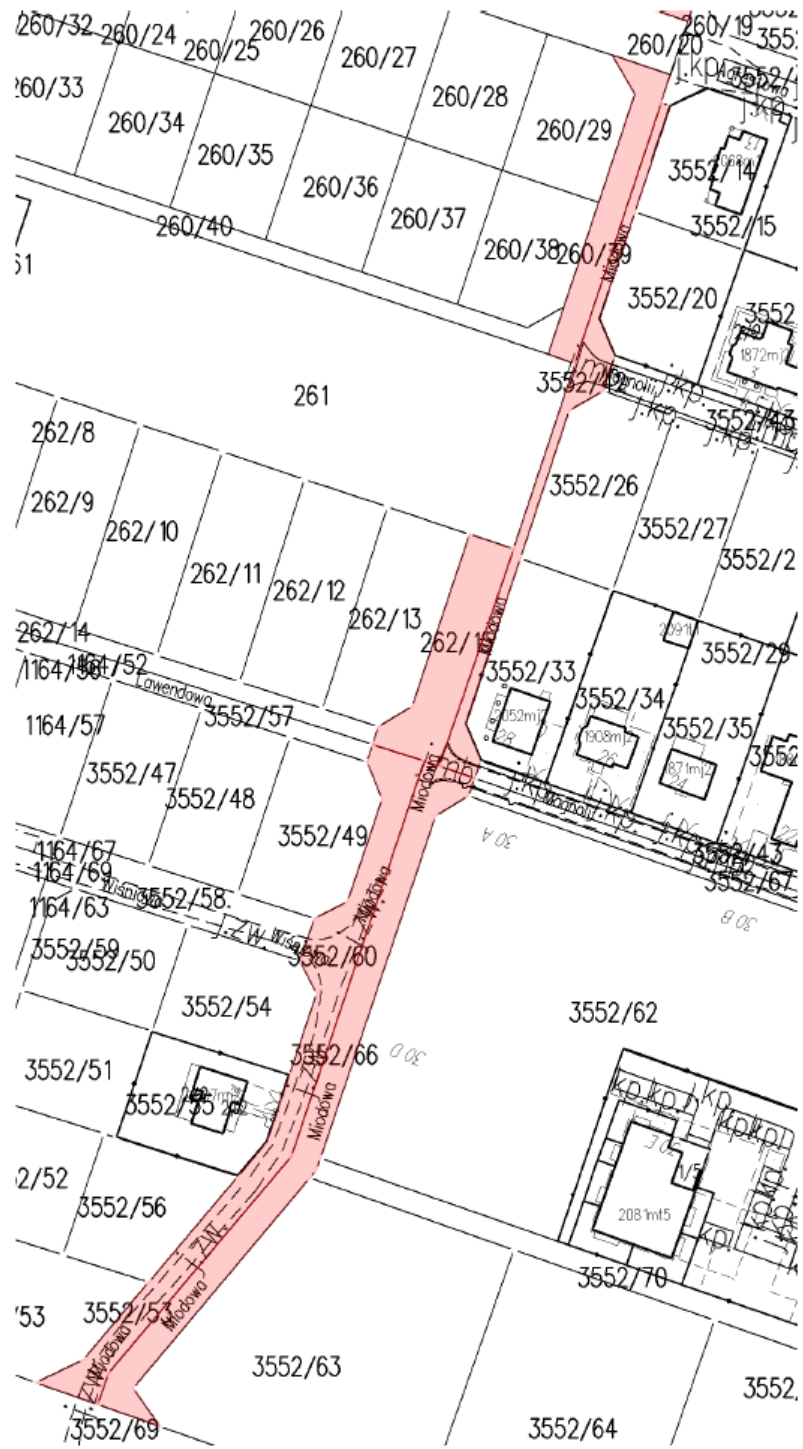

ul. Mirowska (część 1)



ul. Mirowska (część 2)

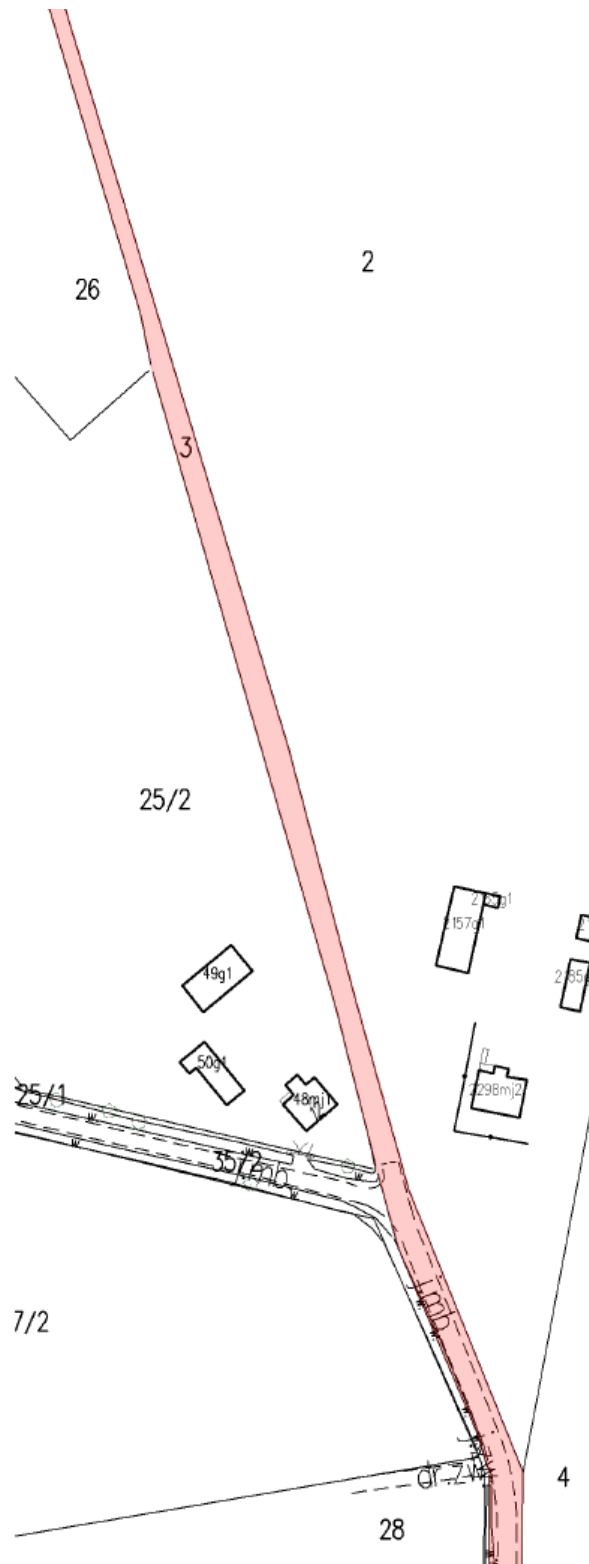

ul. Mirowska (część 3)

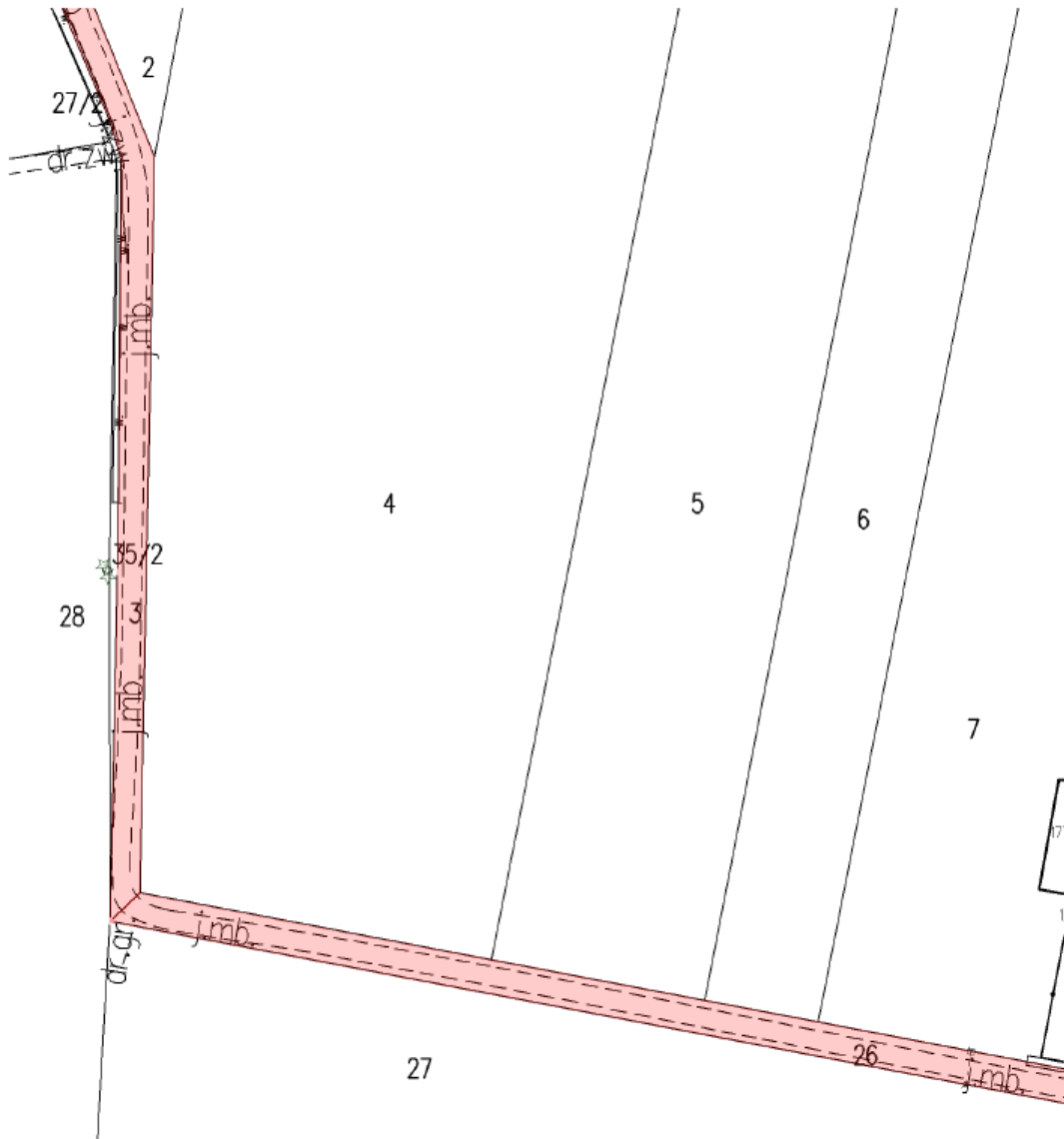

ul. Mirowska (część 4)

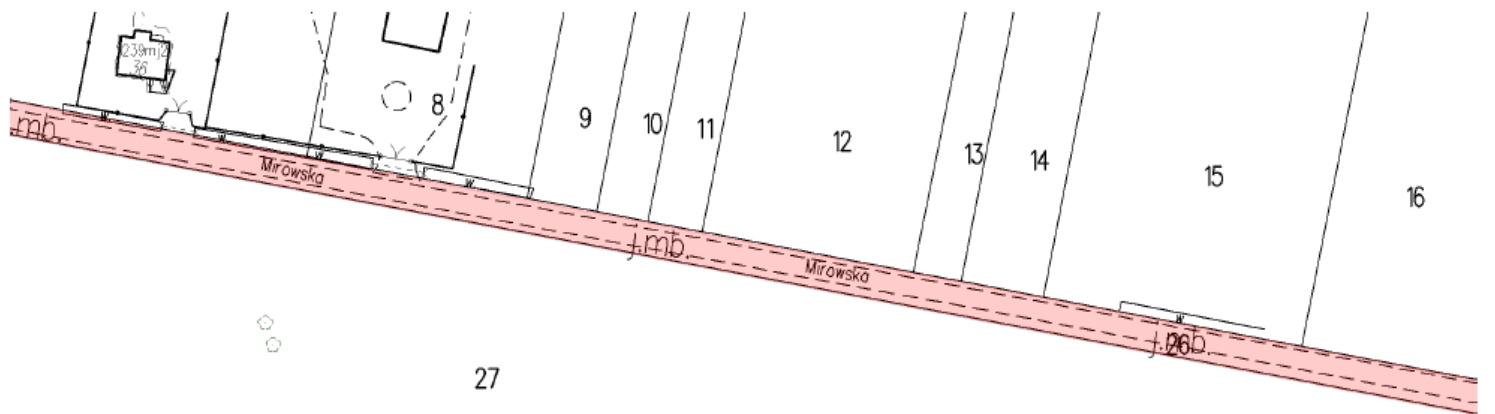

ul. Mirowska (część 5)

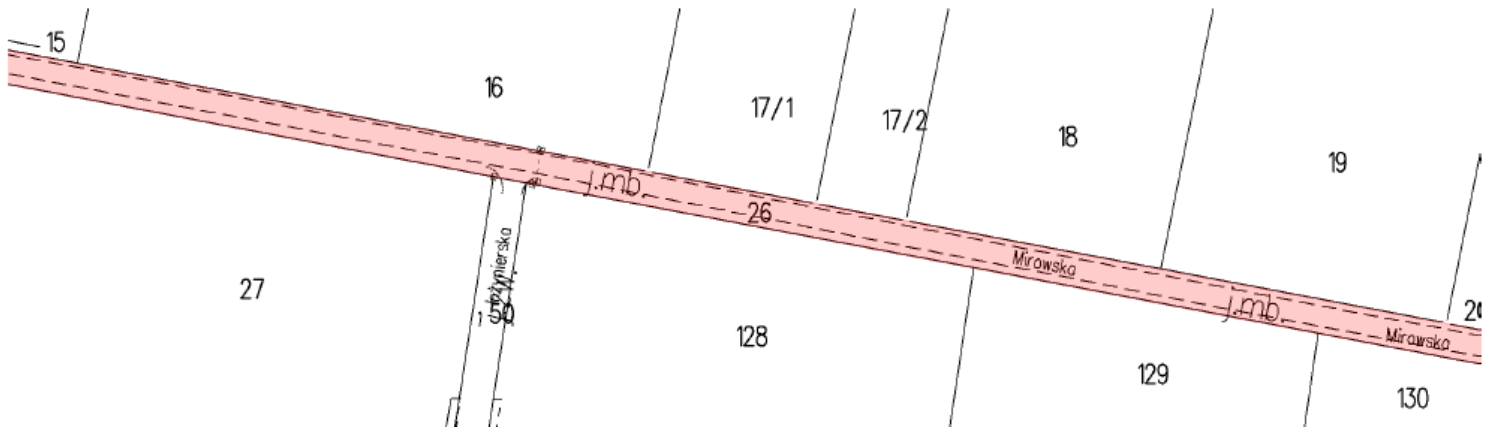

ul. Mirowska (część 6)

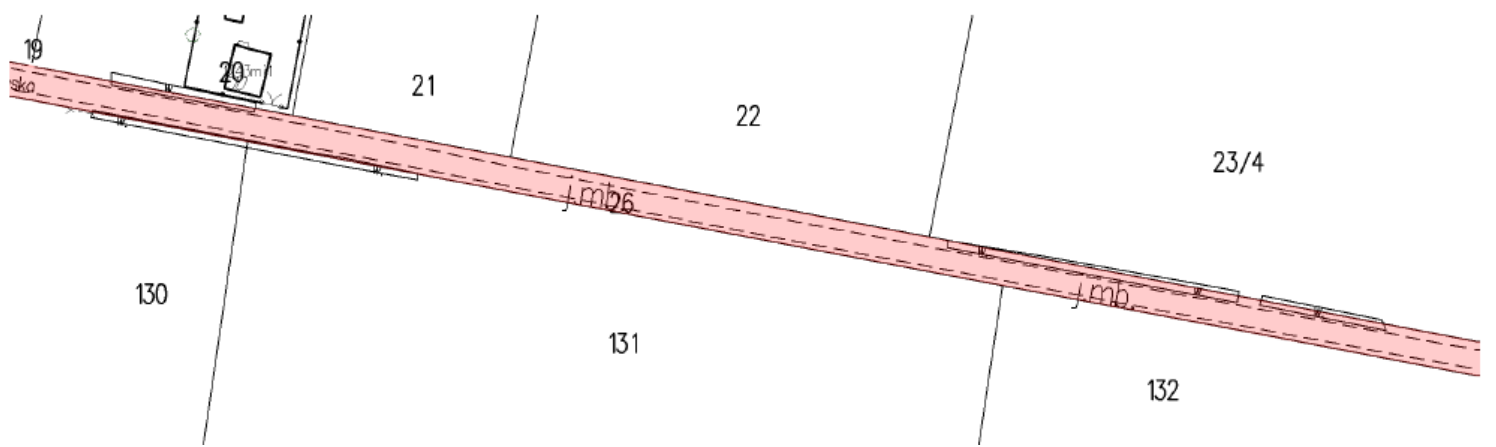

ul. Mirowska (część 7)

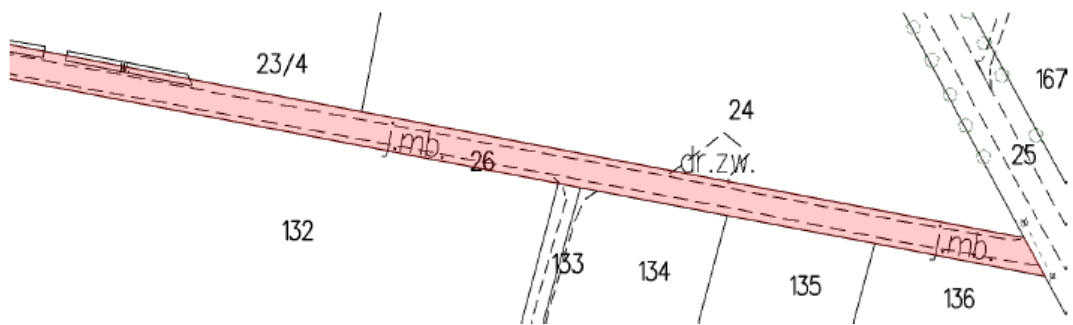

ul. Narutowicza Gabriela

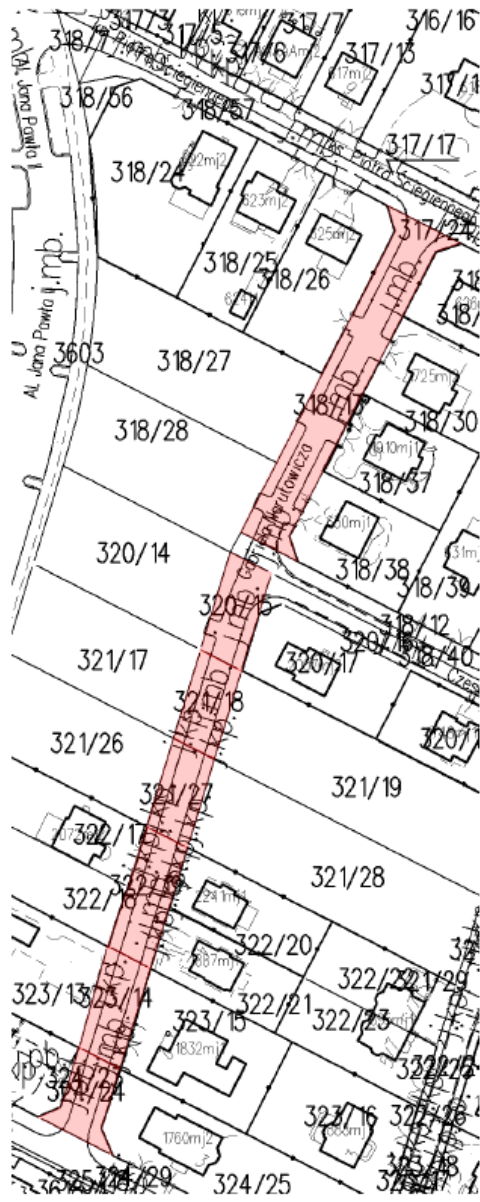

ul. Ogrodowa

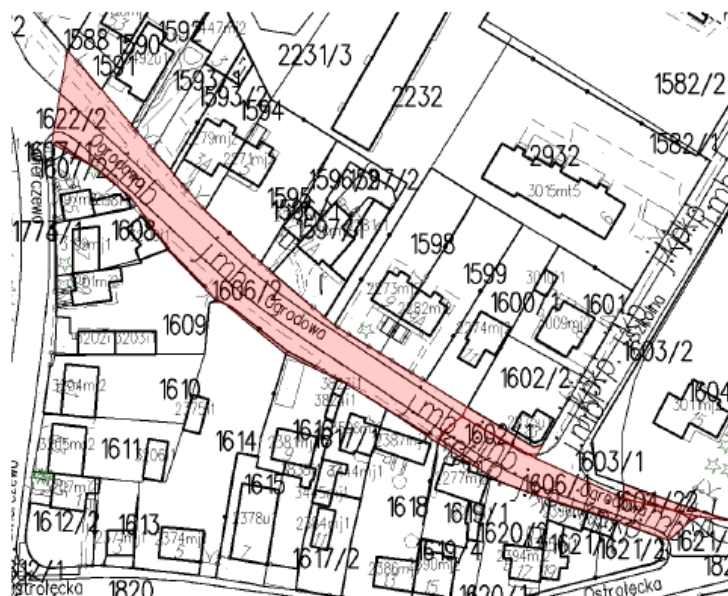

ul. Okopowa

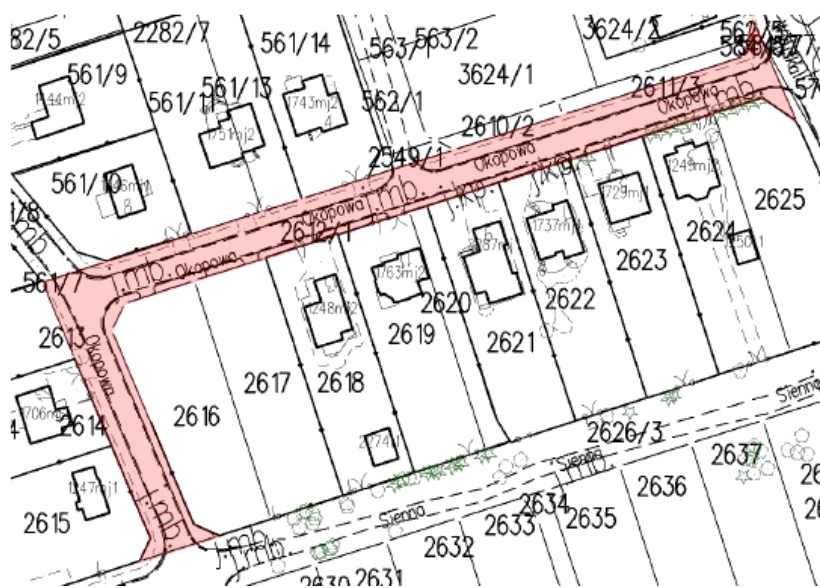

ul. Ostrołęcka

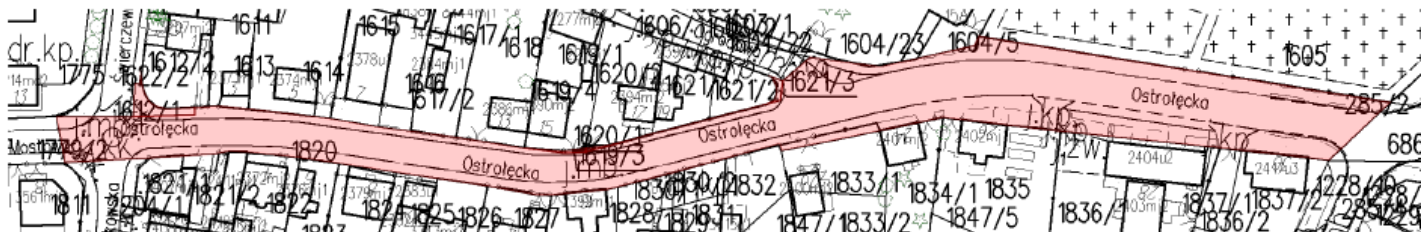

ul. Piaski



ul. Piękna

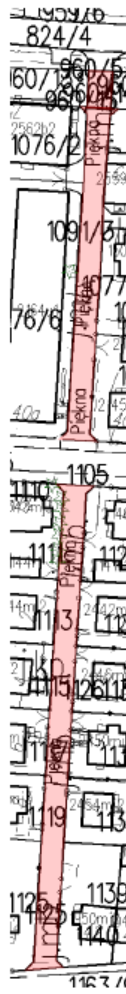

ul. Pileckiego Witolda (część 1)

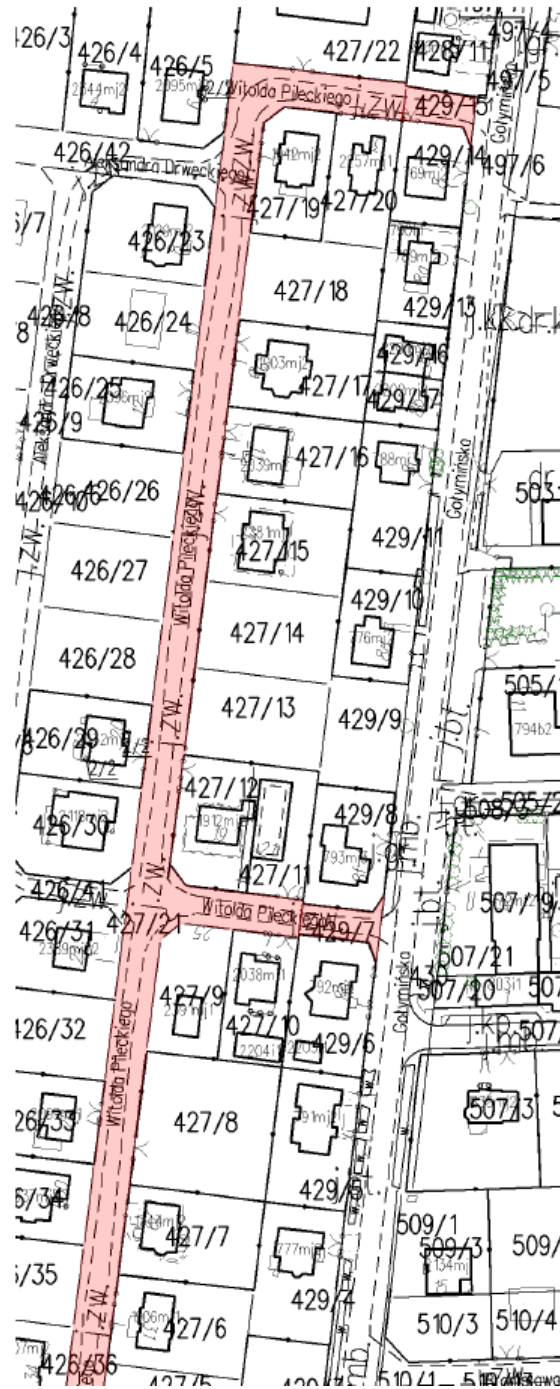

ul. Pileckiego Witolda (część 2)

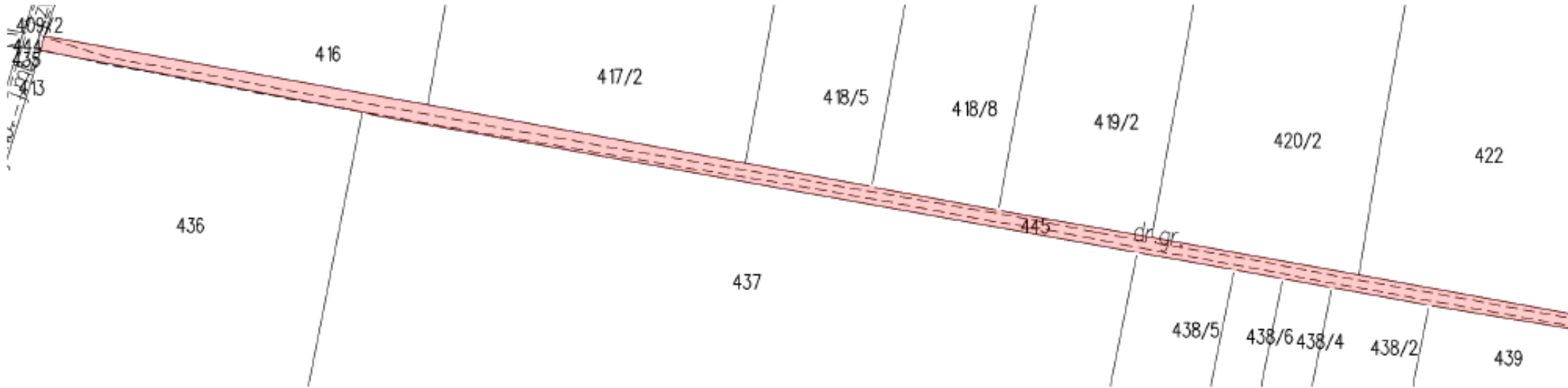

ul. Pileckiego Witolda (część 3)

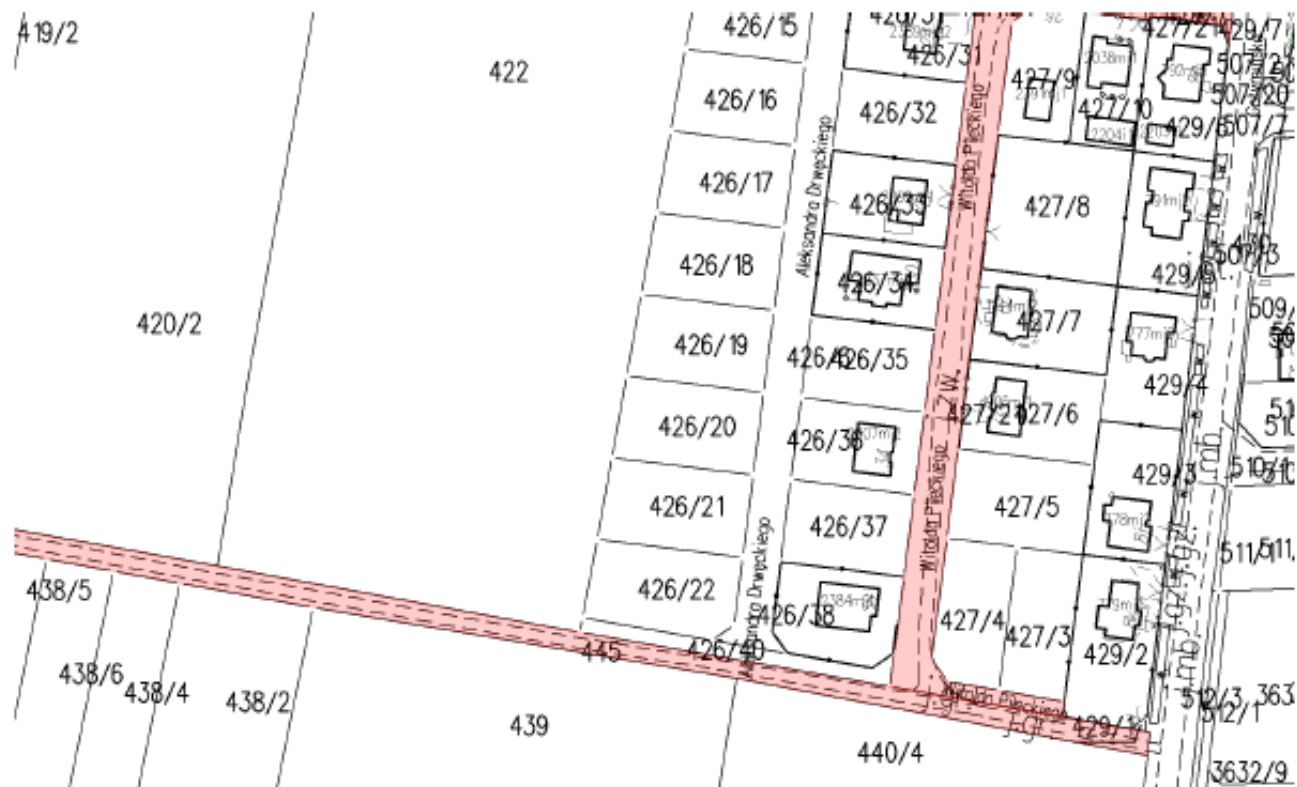

ul. Polna (część 1)



ul. Polna (część 2)

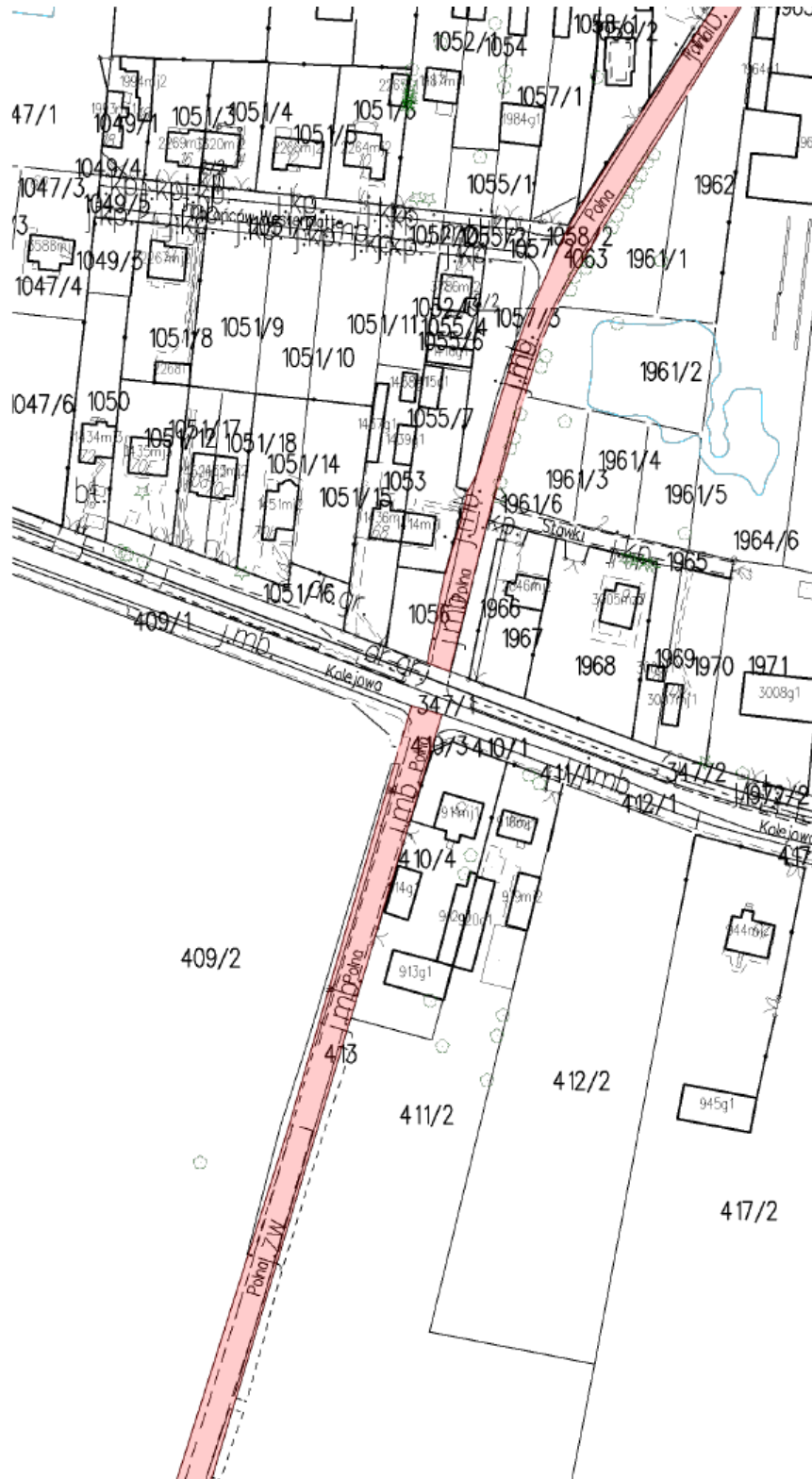

ul. Polna (część 3)

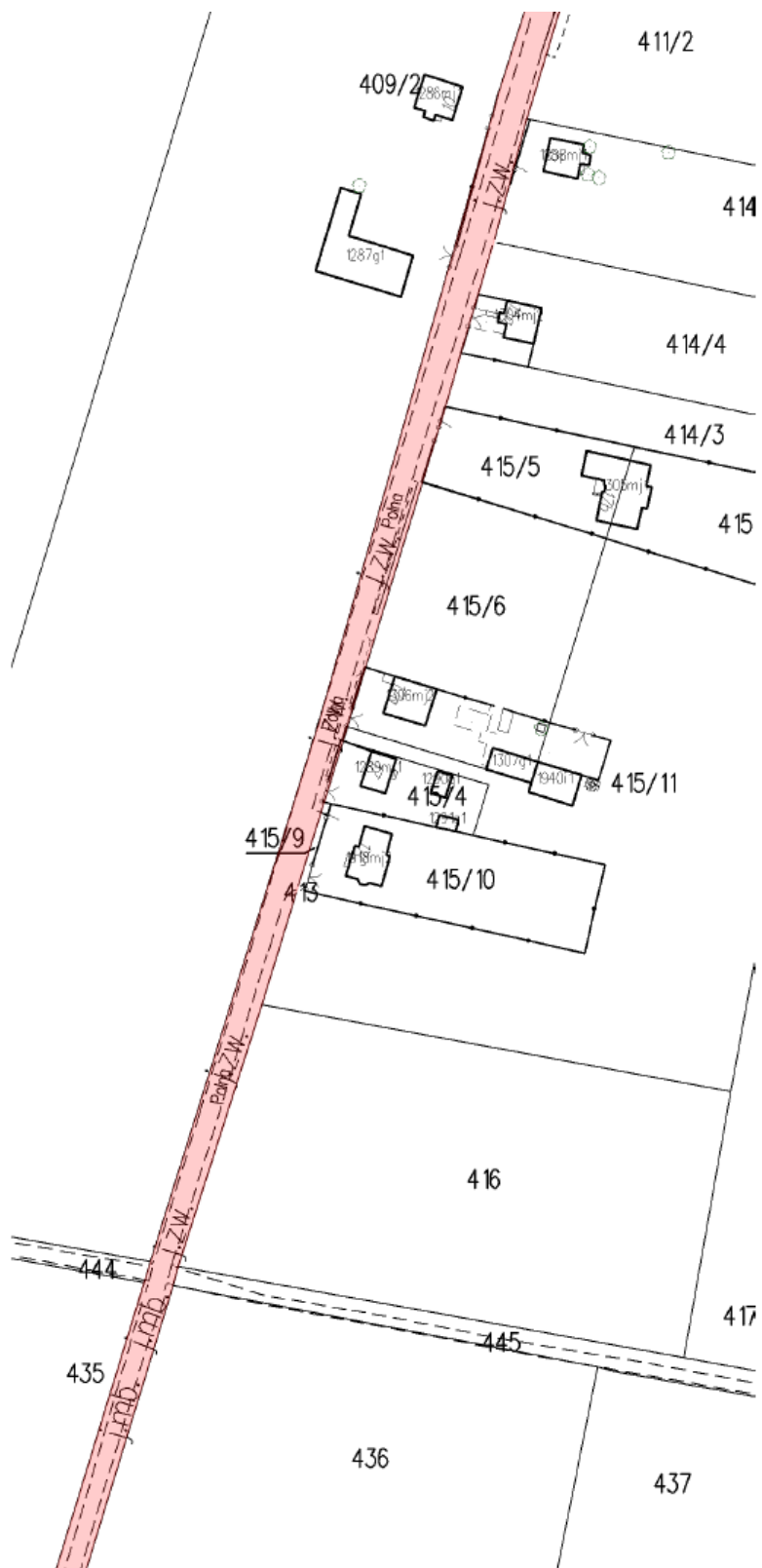

ul. Polna (część 4)

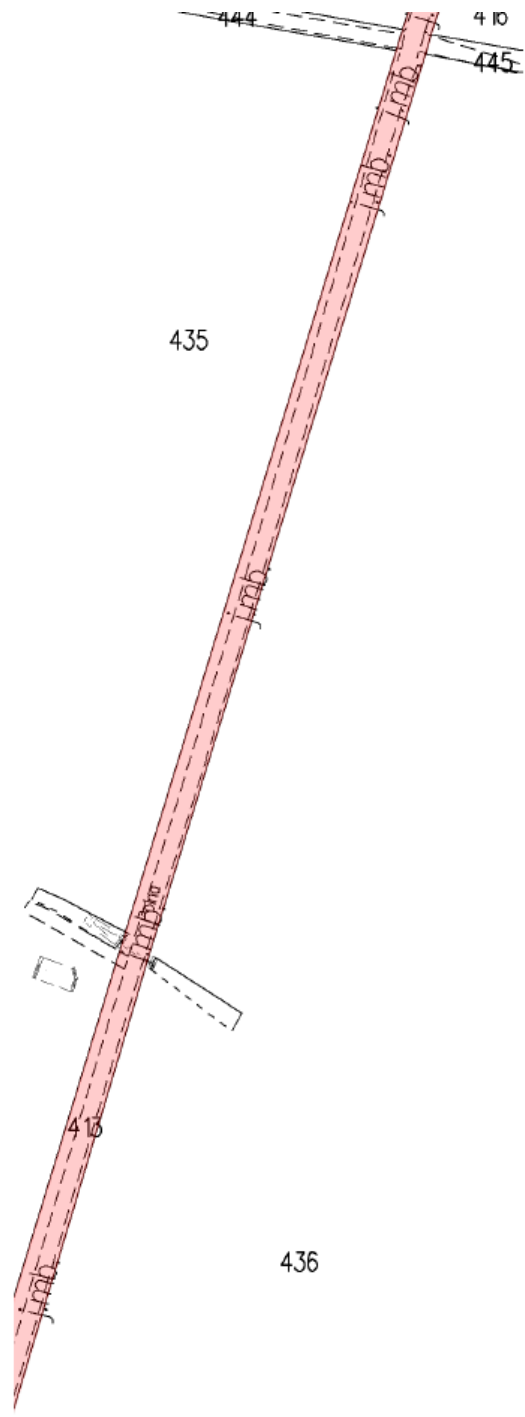

ul. Polna (część 5)

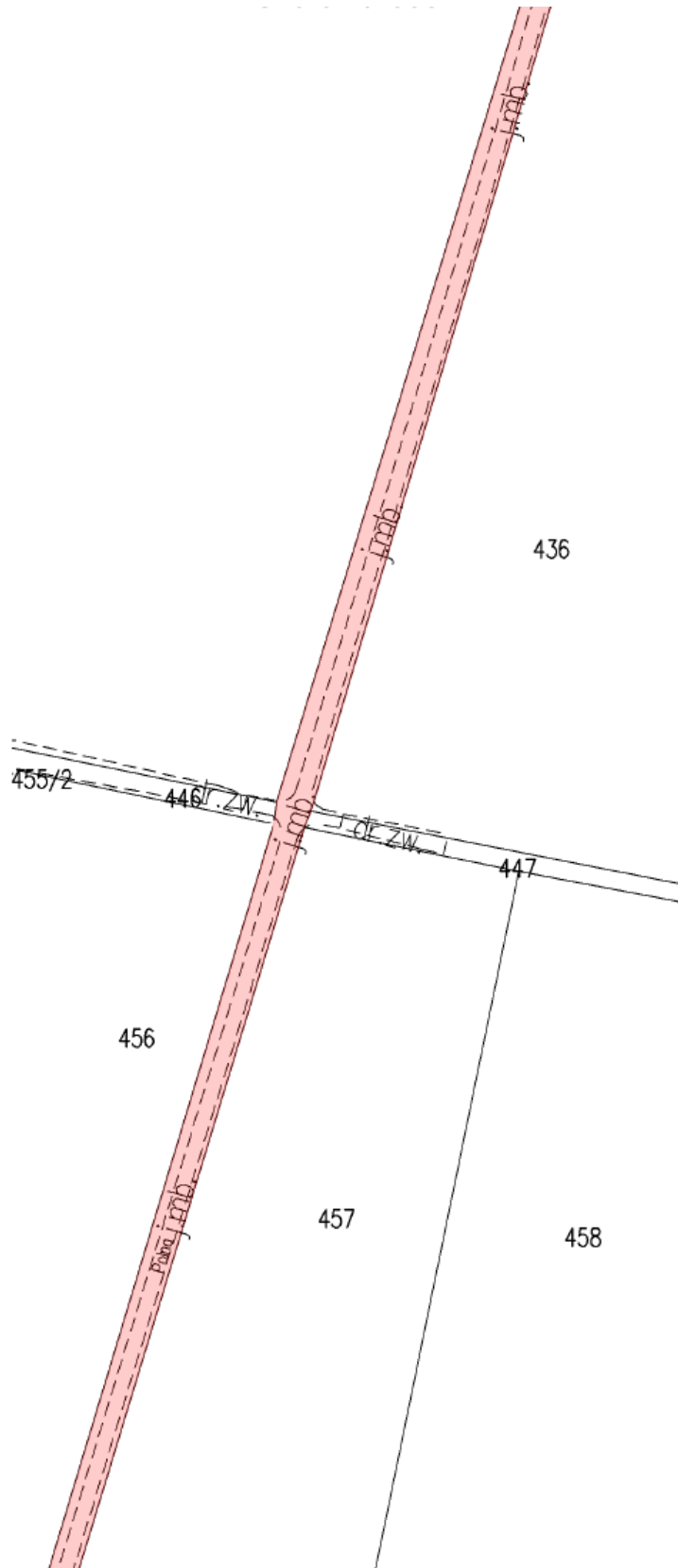

ul. Polna (część 6)



ul. Polna (część 7)



ul. Polna (część 8)



ul. Polna (część 9)

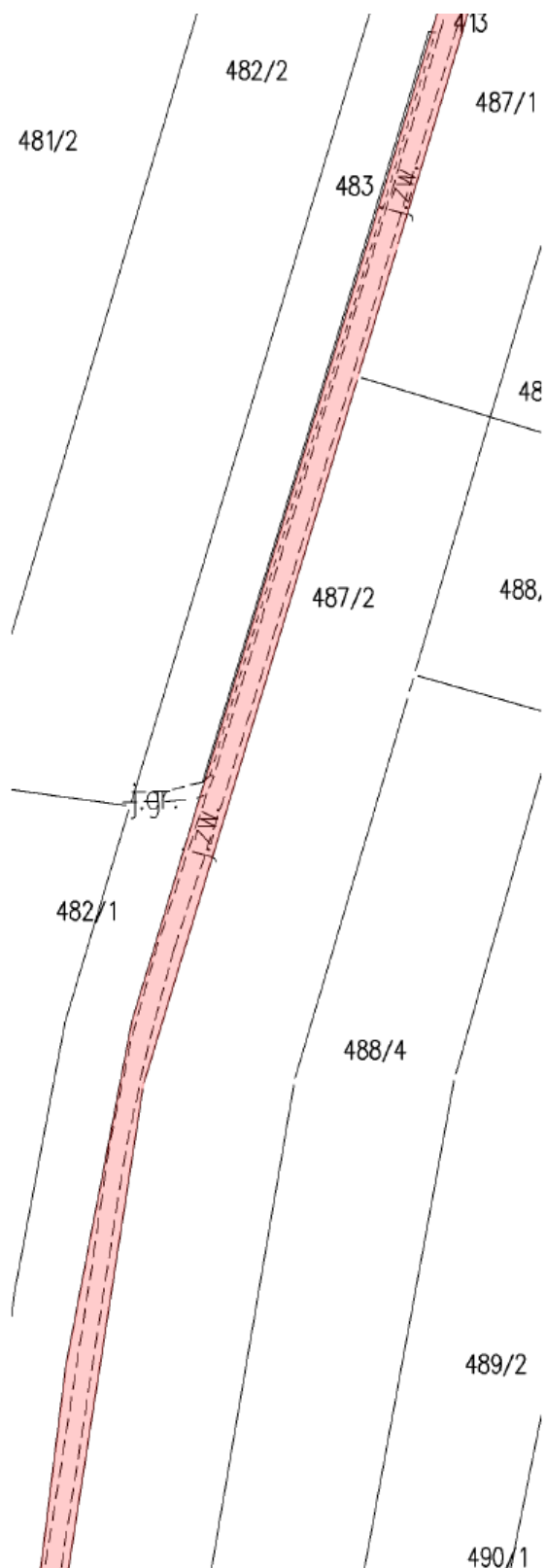

ul. Polna (część 10)

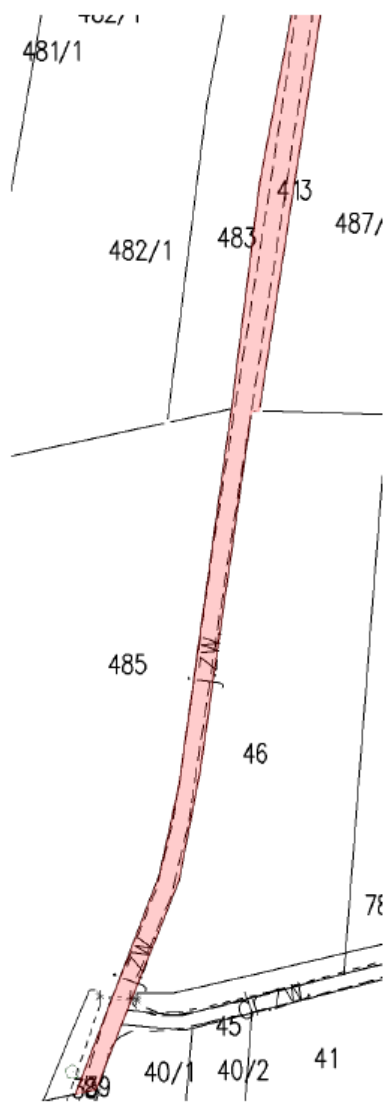

ul. Poziomkowa

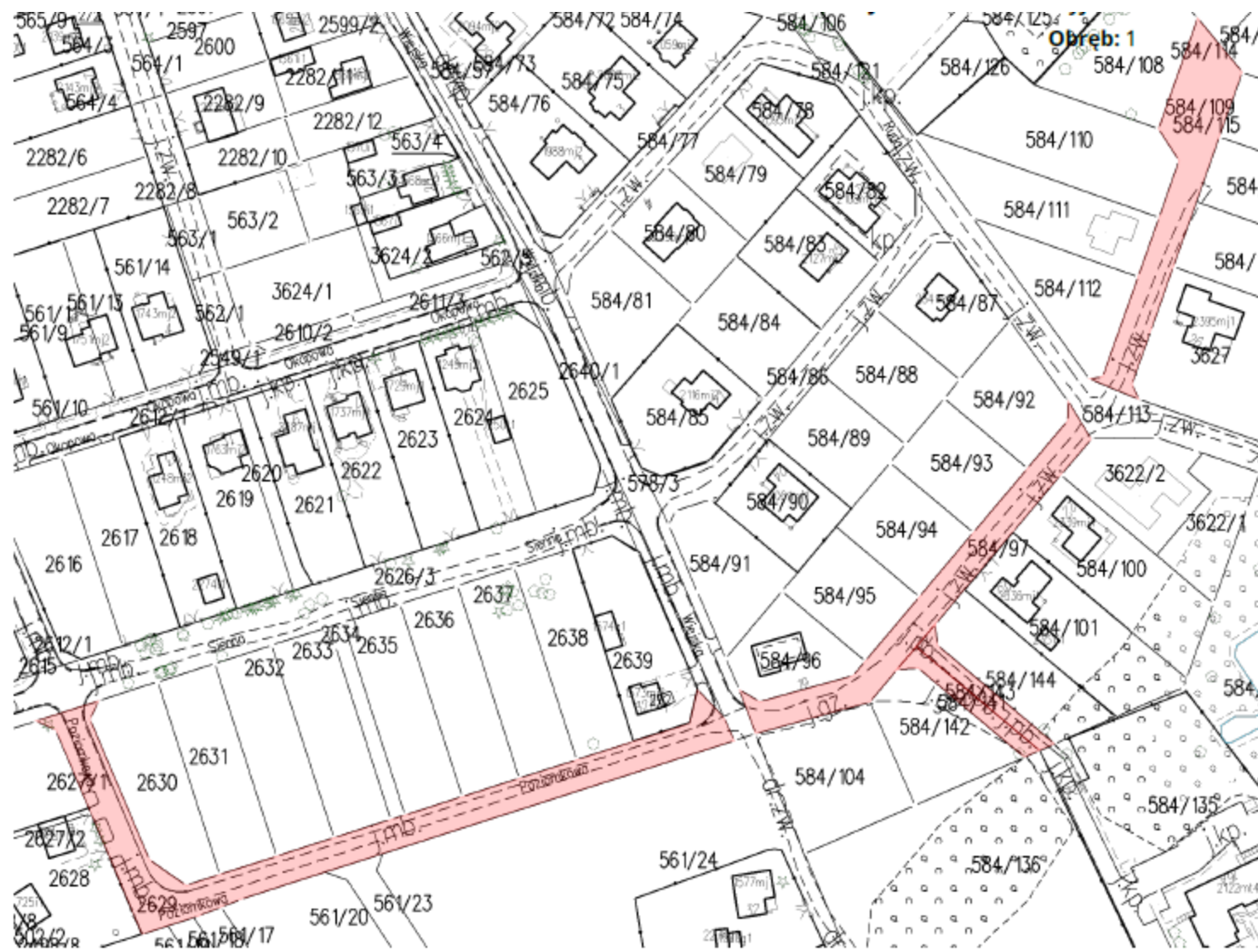

ul. Prosta

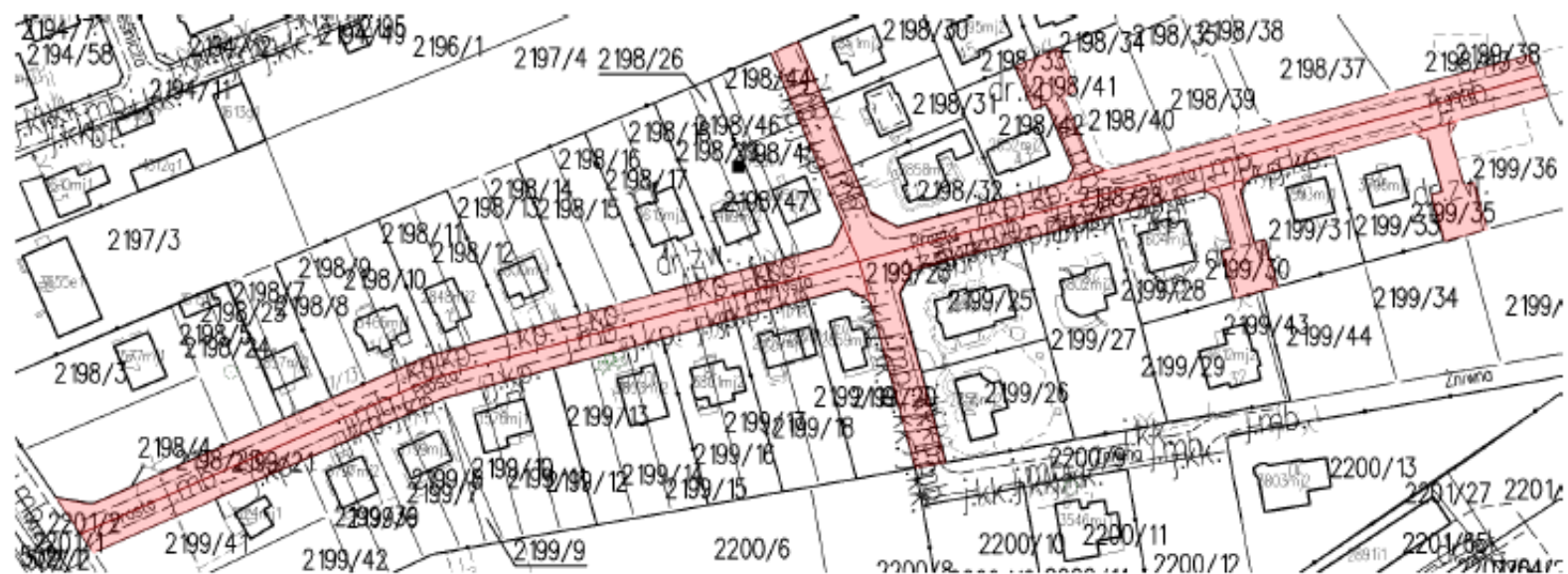

ul. Przemysłowa (część 1)

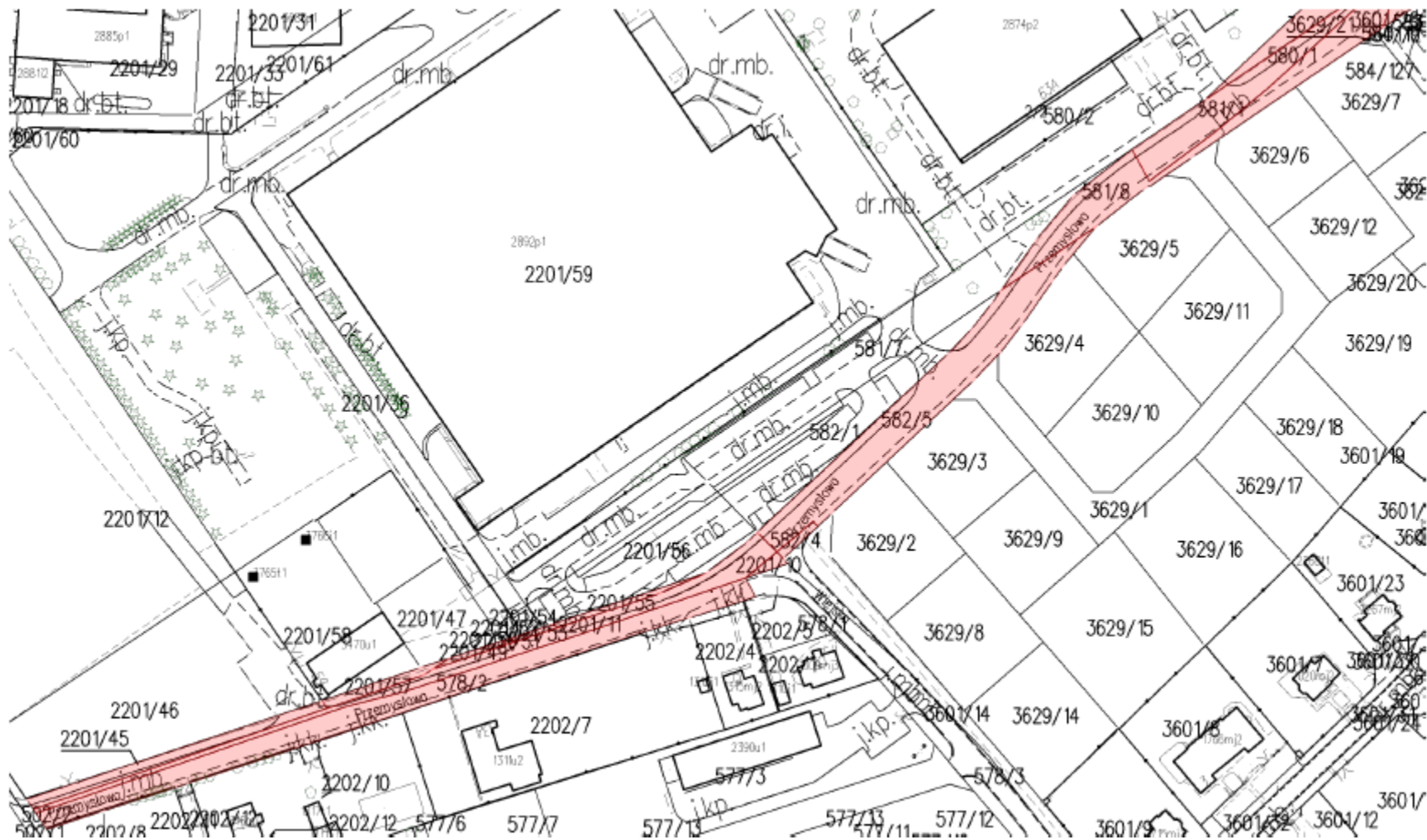

ul. Przemysłowa (część 2)



ul. Pstra

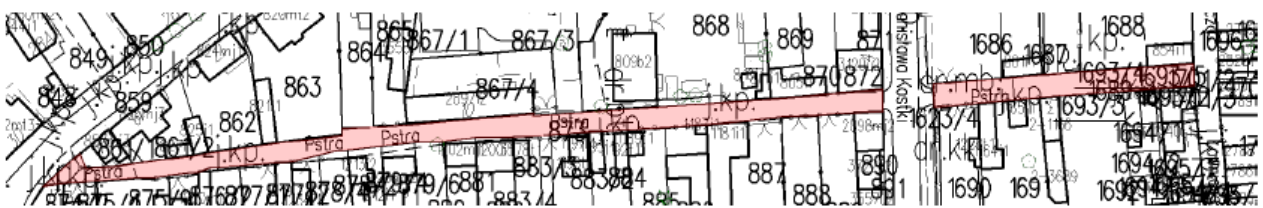

ul. Pukiańca Konstatego



ul. Rolnicza (część 1)



ul. Rolnicza (część 2)

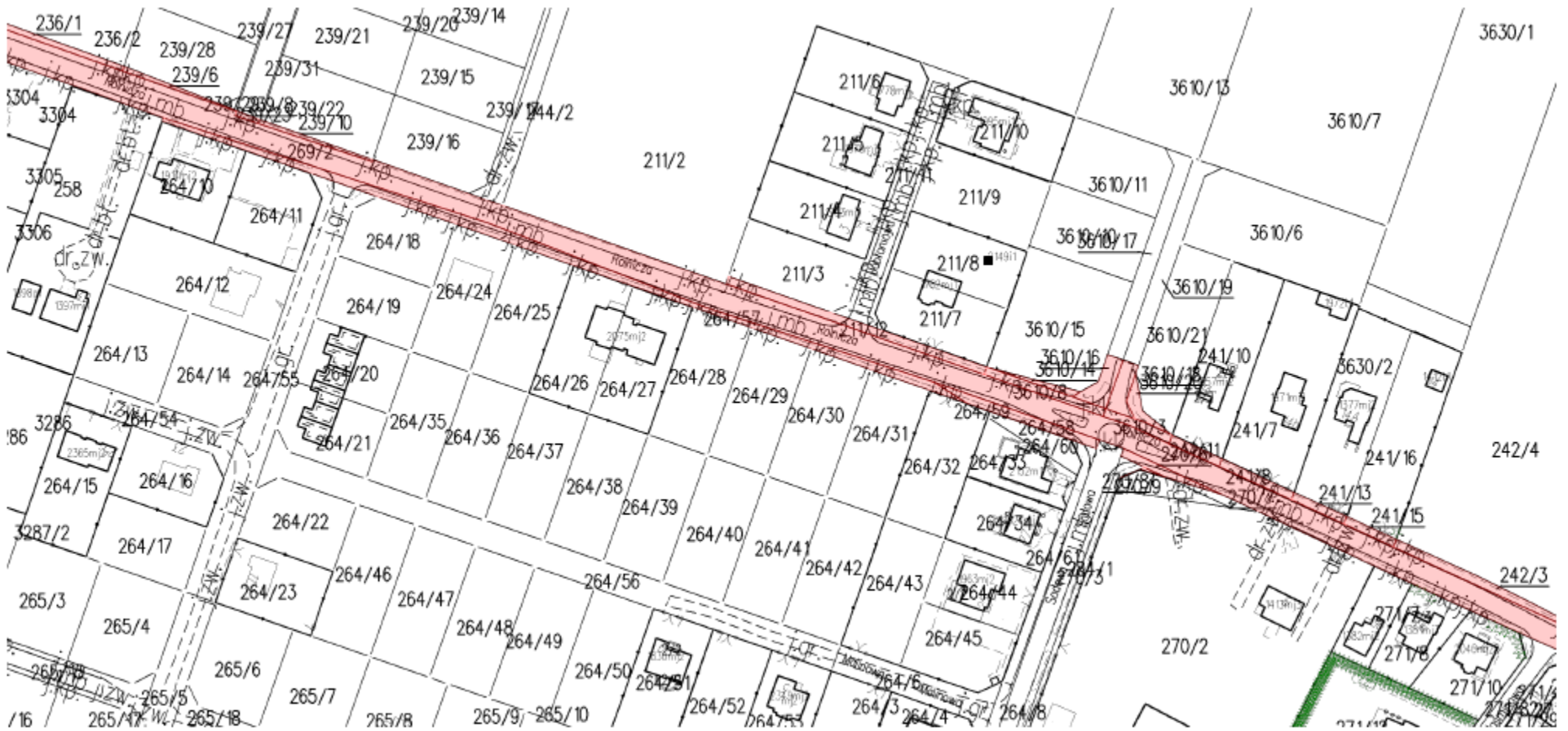

ul. Rolnicza (część 3)

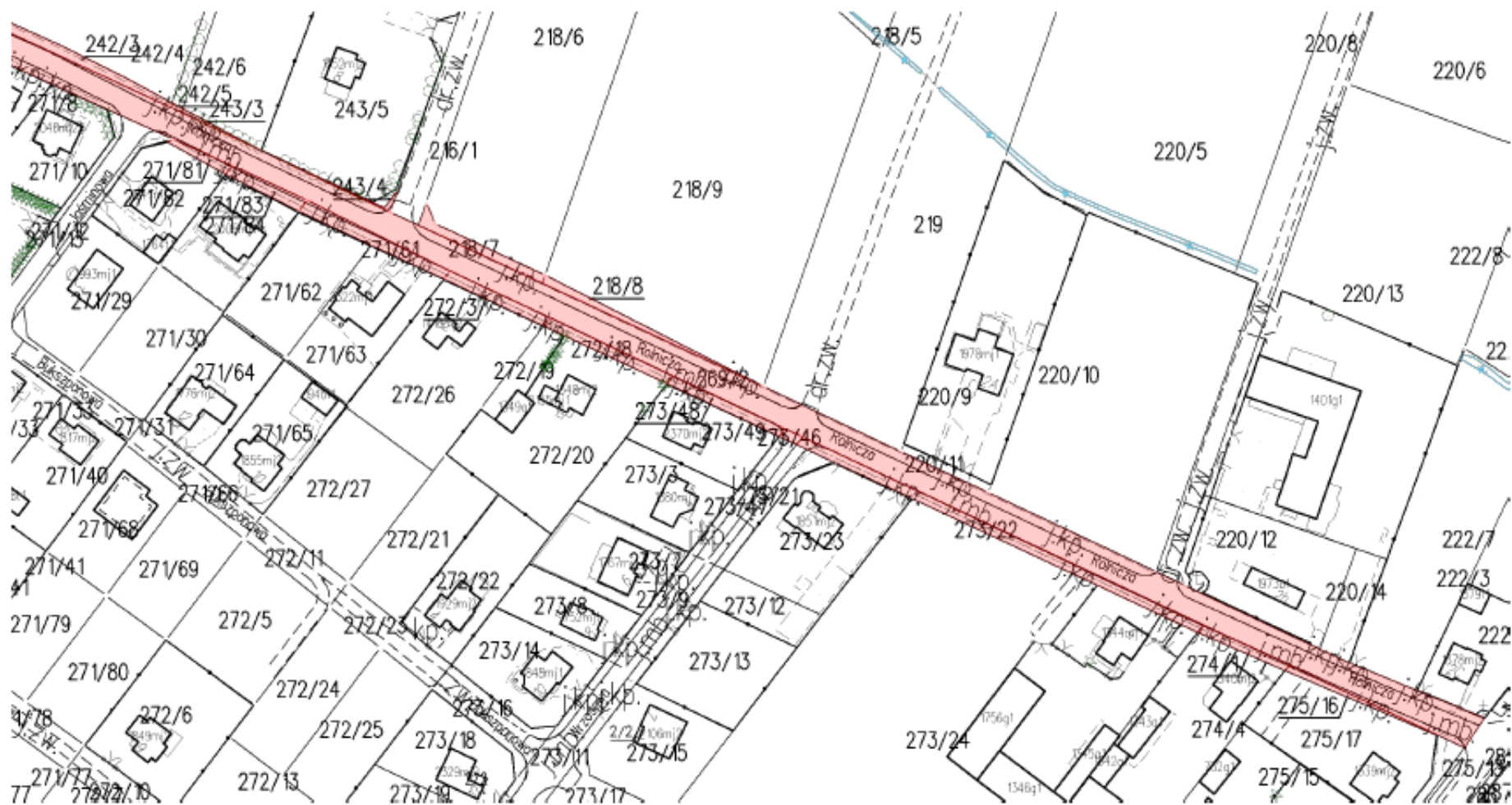

ul. Rostkowska (część 1)

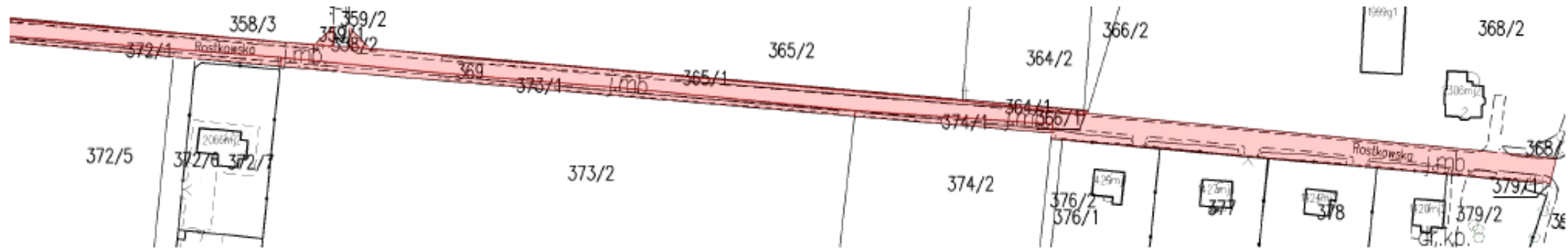

ul. Rostkowska (część 2)



ul. Rubinowa



ul. Rumiankowa

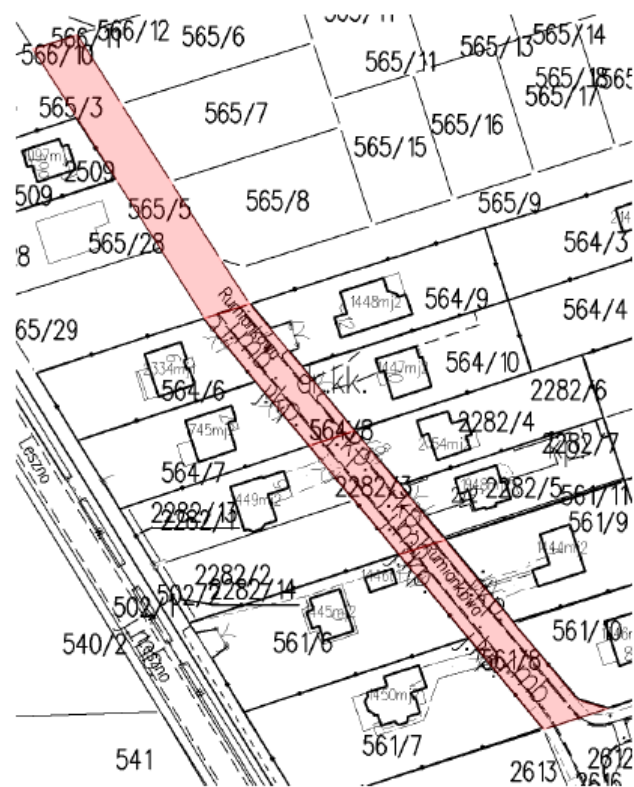

ul. Rycerska

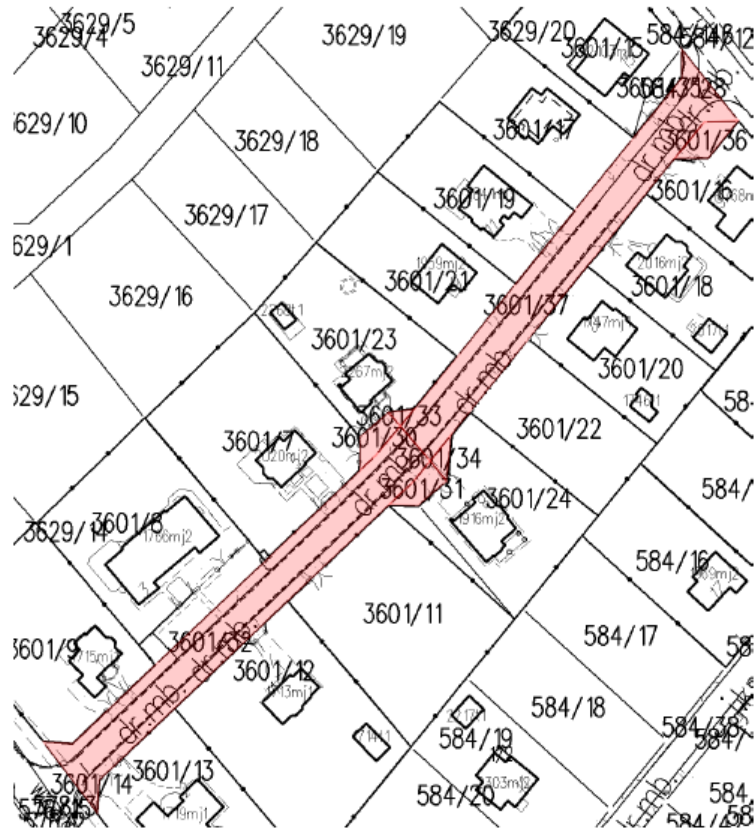

ul. Rzemieśnicza

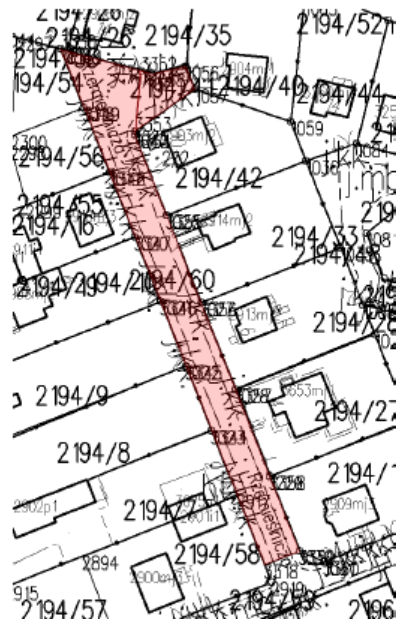

ul. Sadowa (część 1)

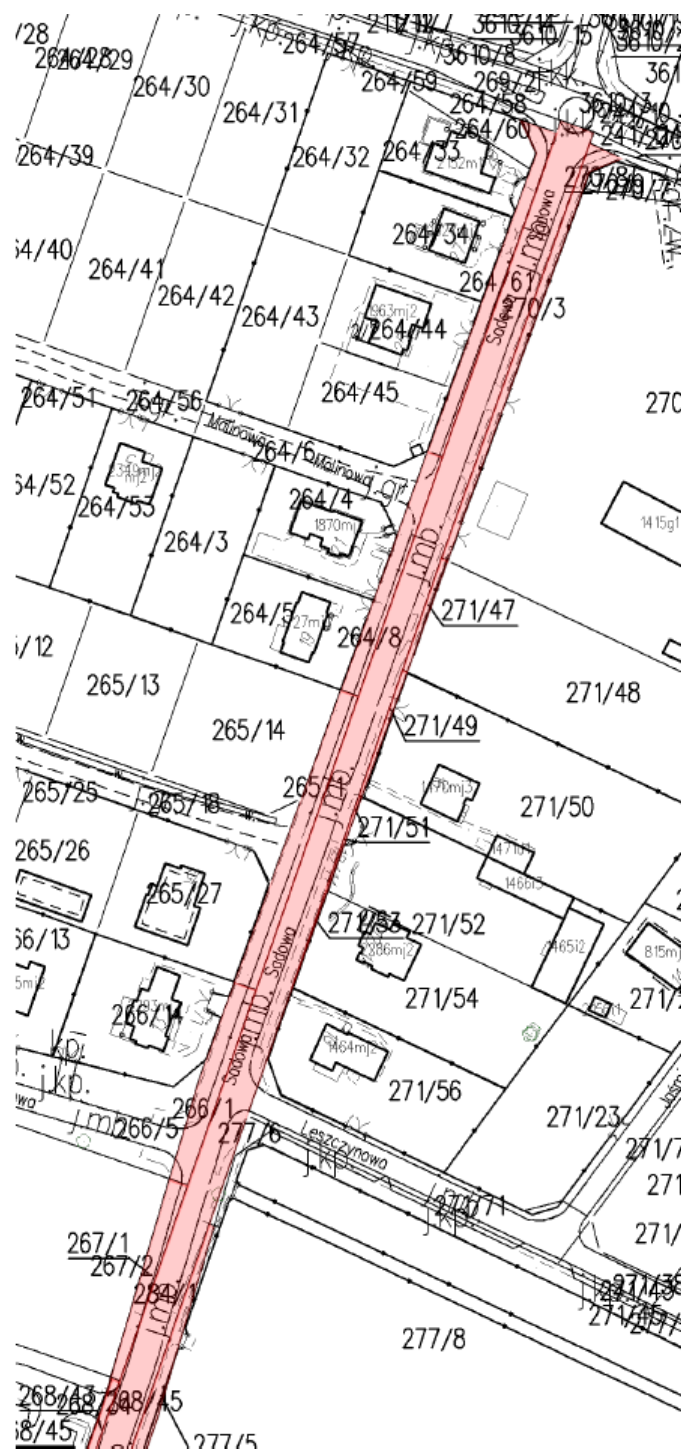

ul. Sadowa (część 2)

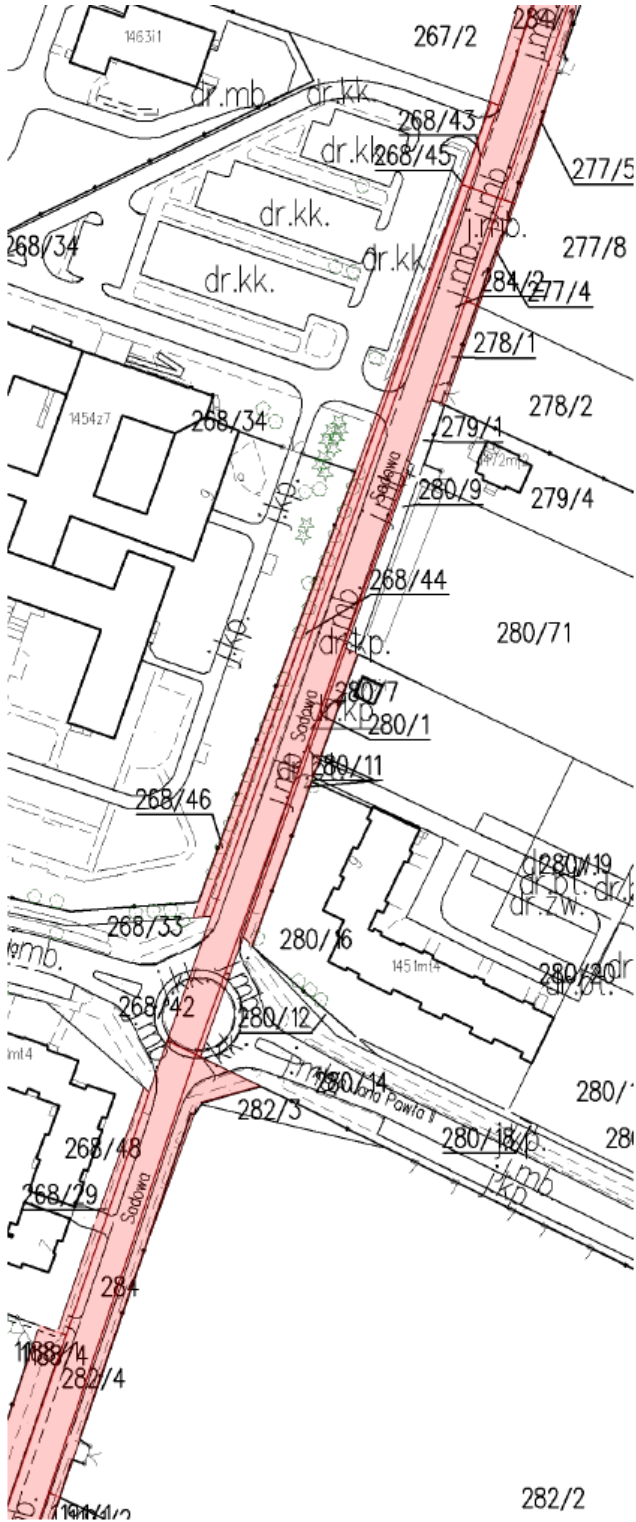

ul. Sadowa (część 3)

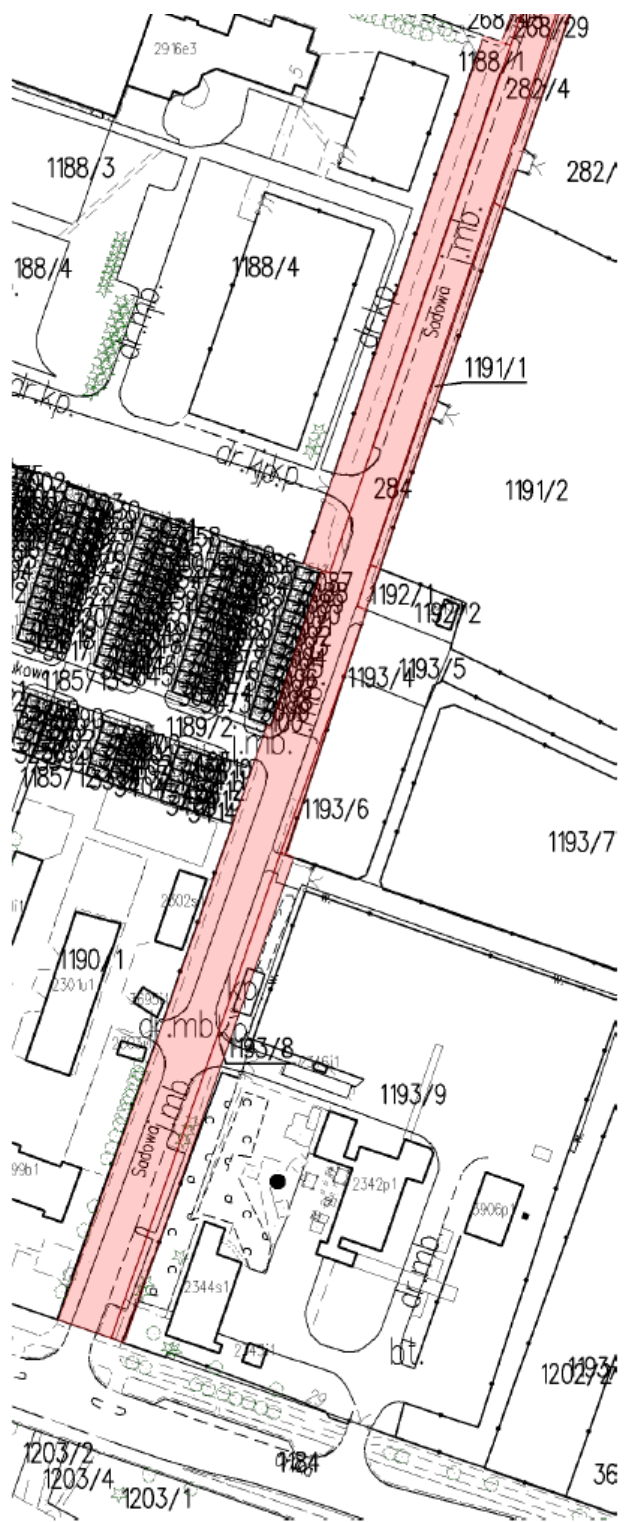

ul. Sienna

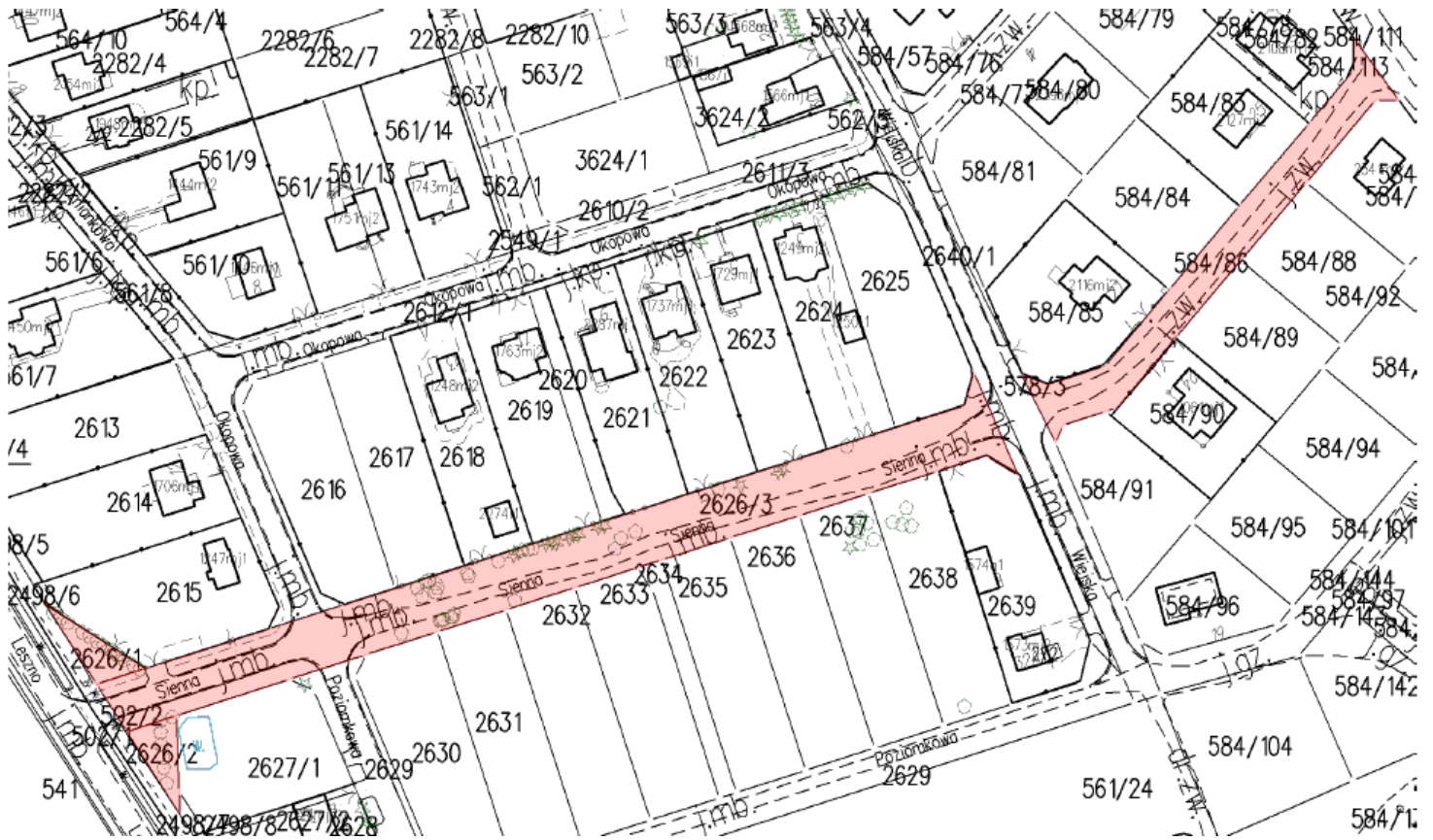

ul. Skłodowskiej -Curie Marii

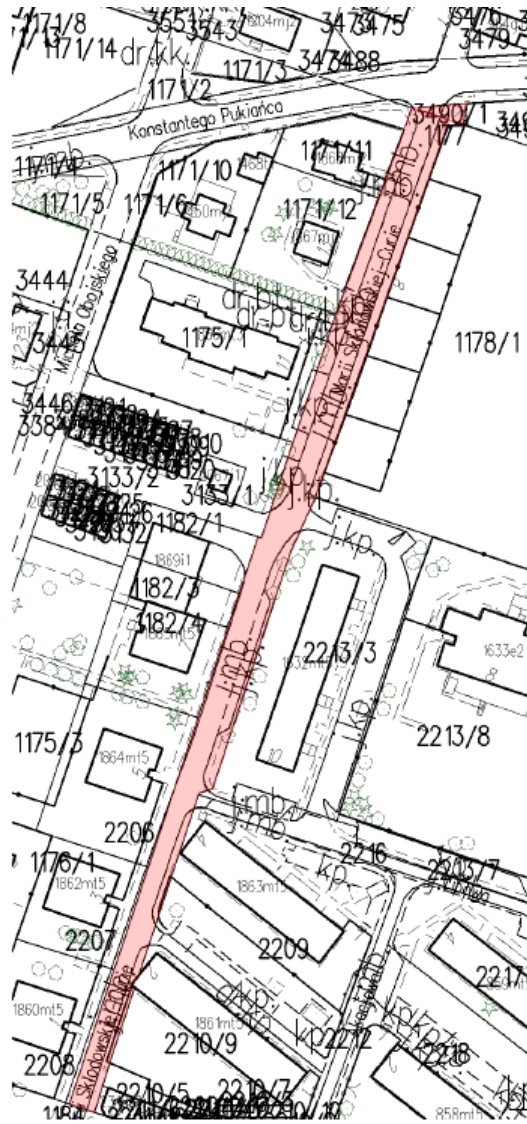

ul. Słoneczna

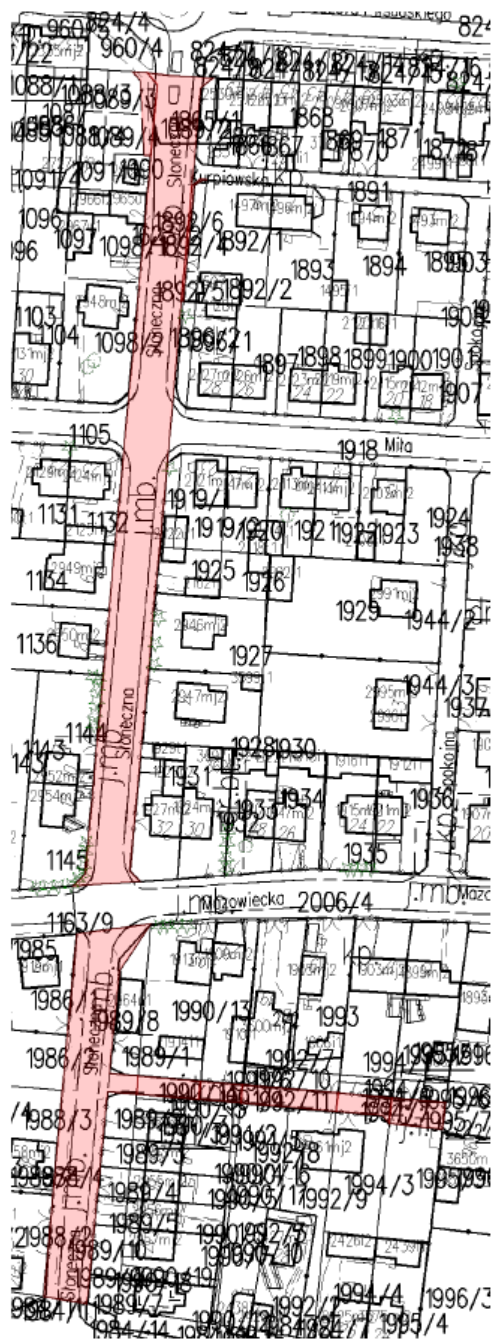

ul. Spacerowa

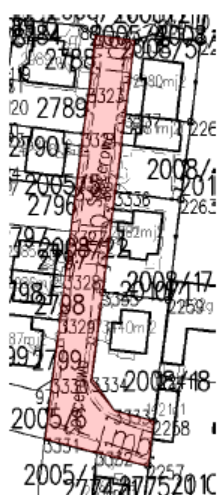

ul. Szkolna

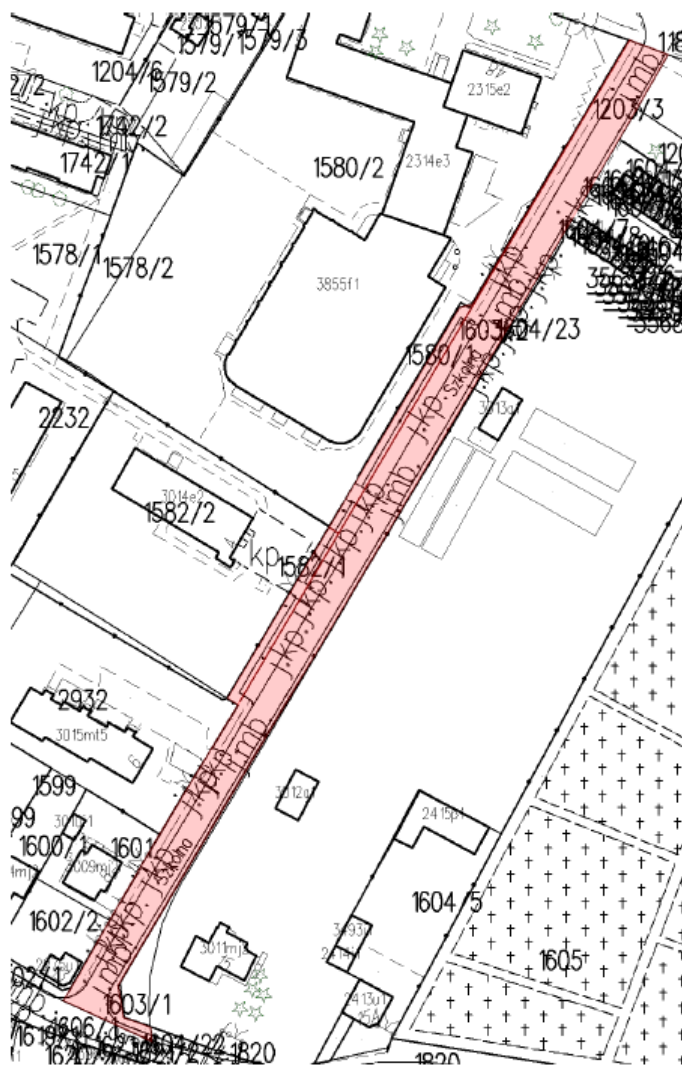

ul. św. Floriana

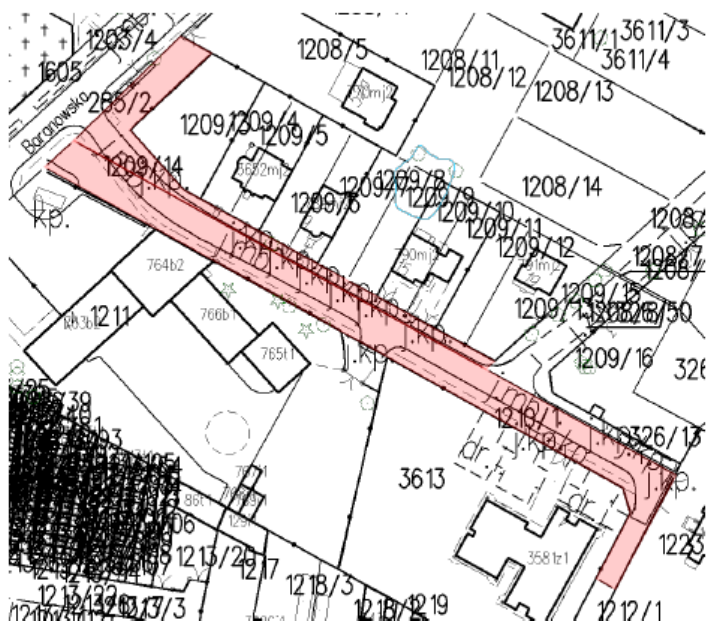

ul. św. Kingi

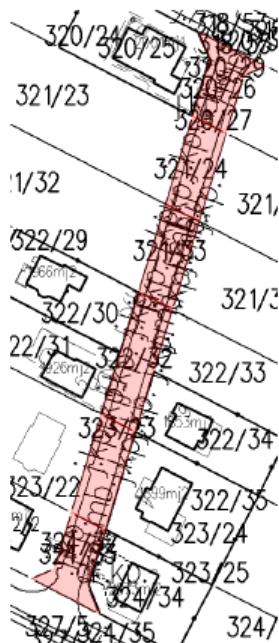

ul. św. Krzysztofa

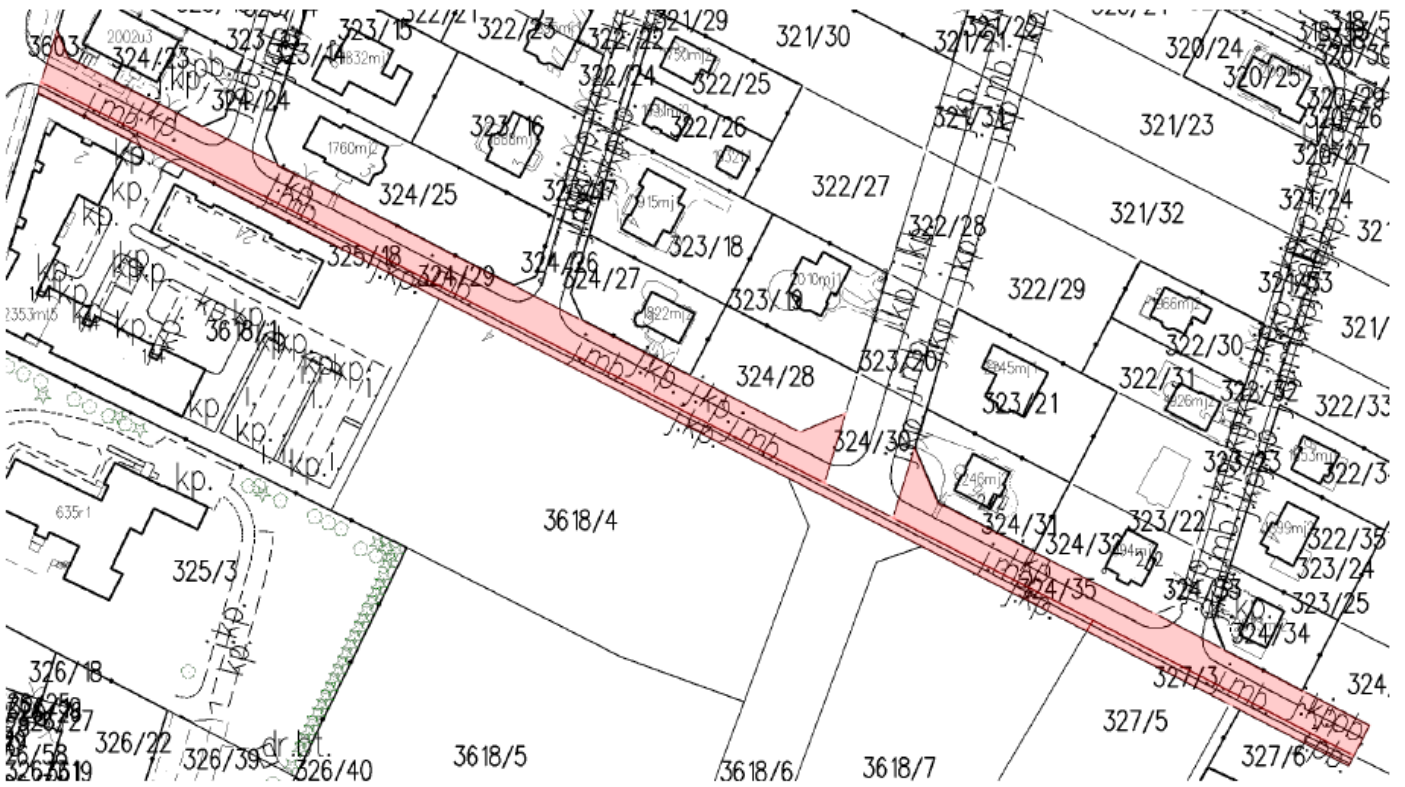

ul. Świerczewo (część 1)

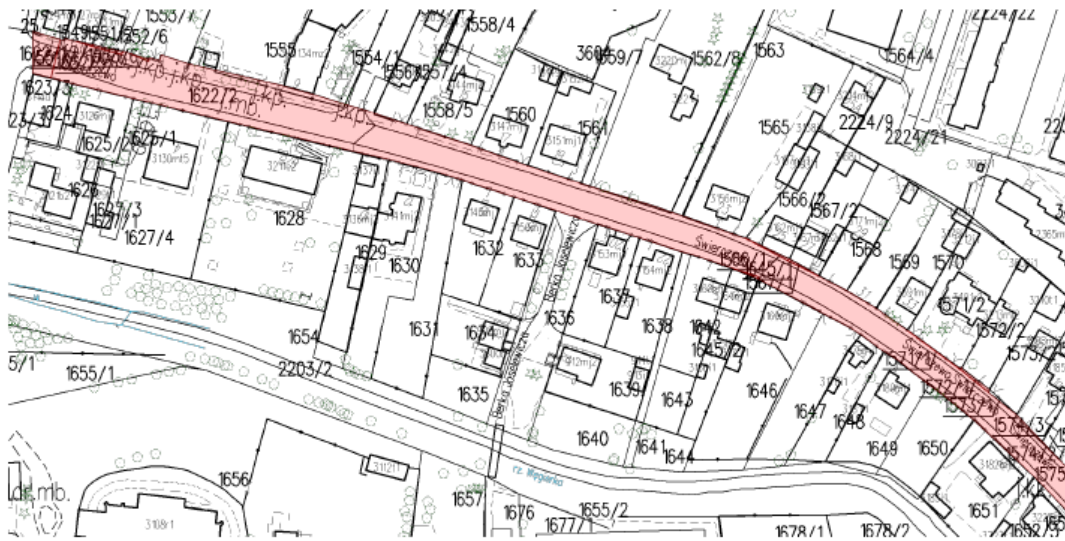

ul. Świerczewo (część 2)

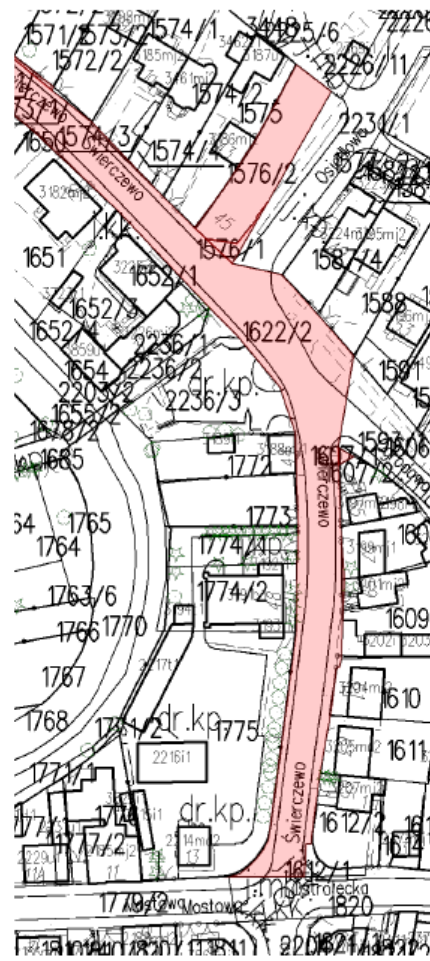

ul. Wiejska (część 1)

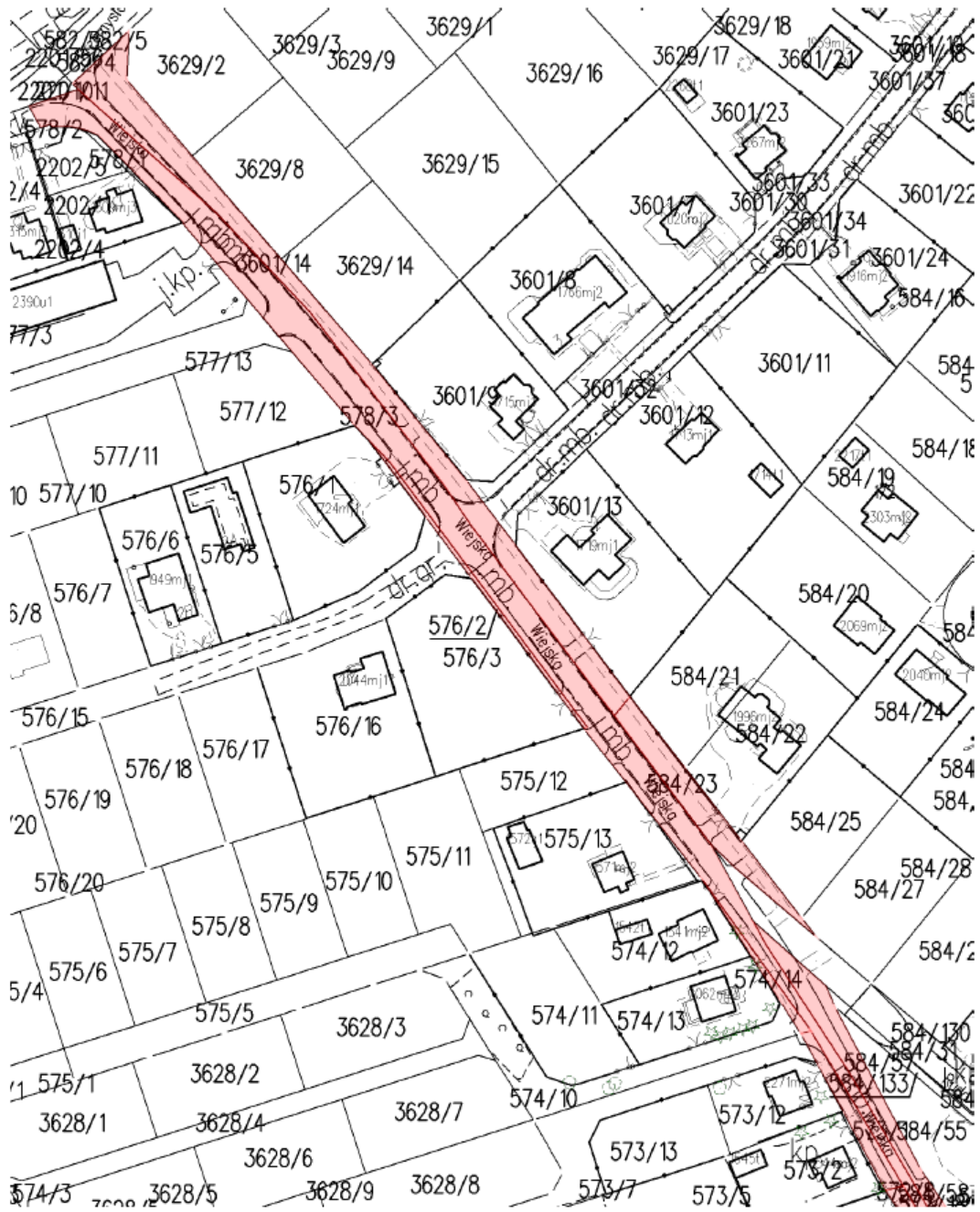

ul. Wiejska (część 2)



ul. Wiejska (część 3)



ul. Wiśniowa

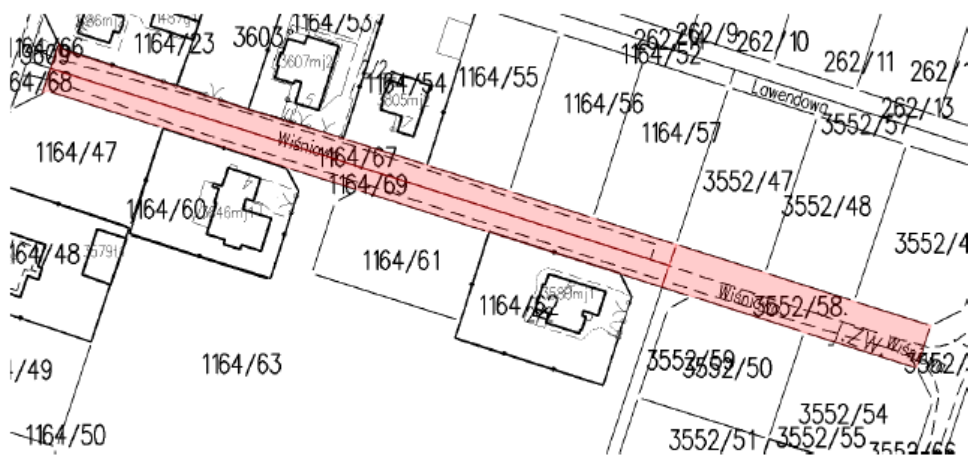

ul. Wojskowa (część 1)

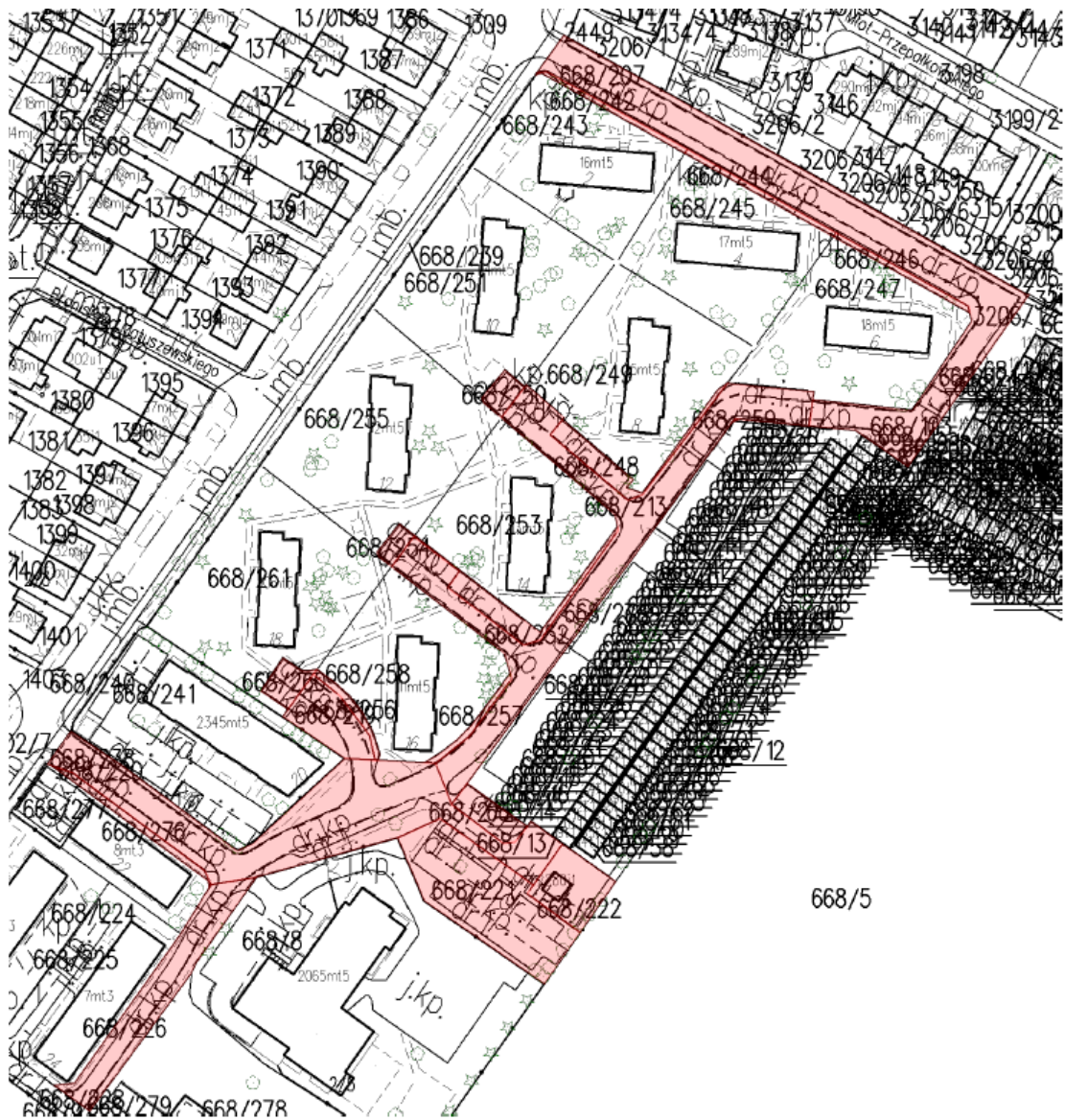

ul. Wojskowa (część 2)

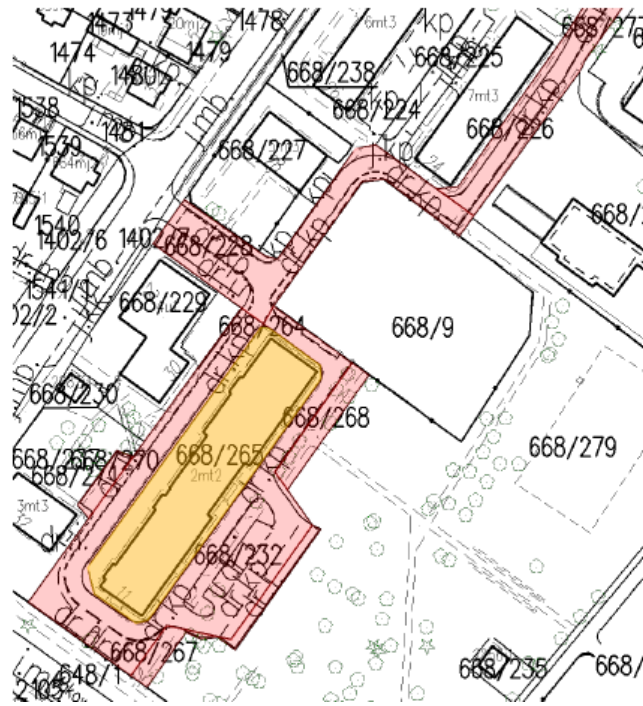

ul. Wrzosowa

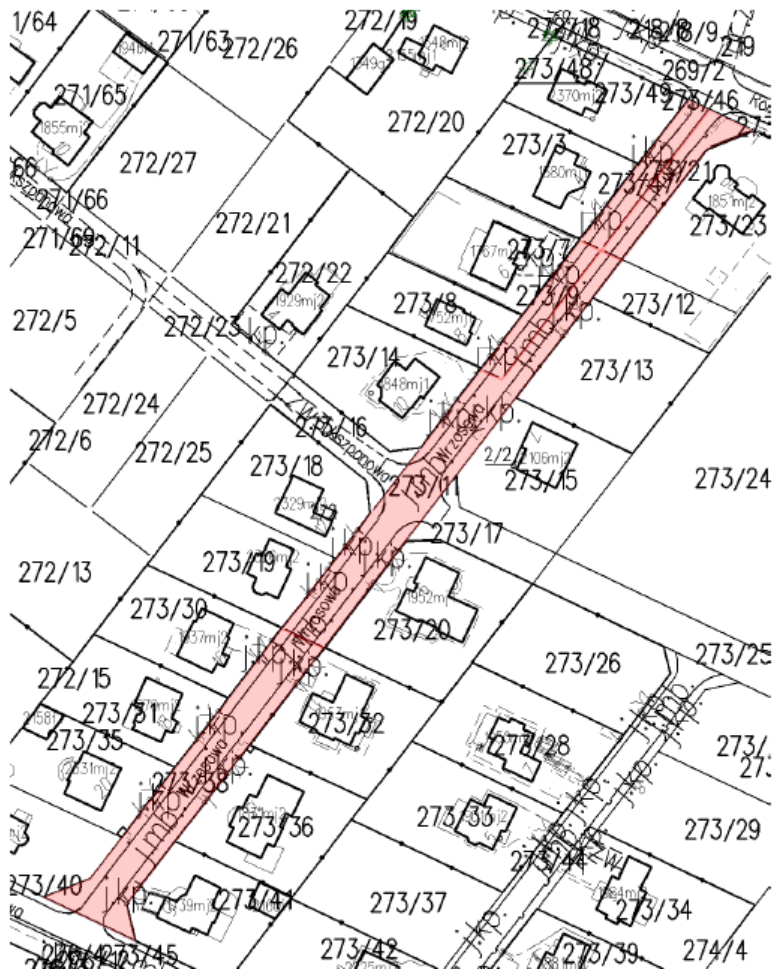

ul. Zaciszna

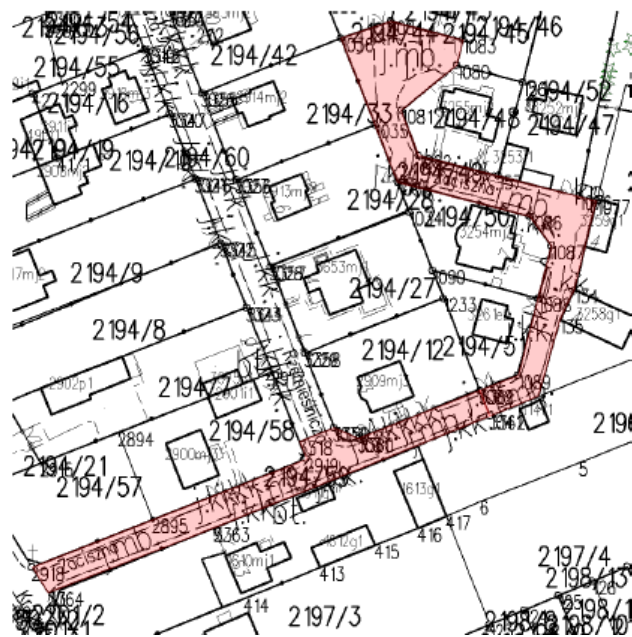

ul. Żytnia (część 1)

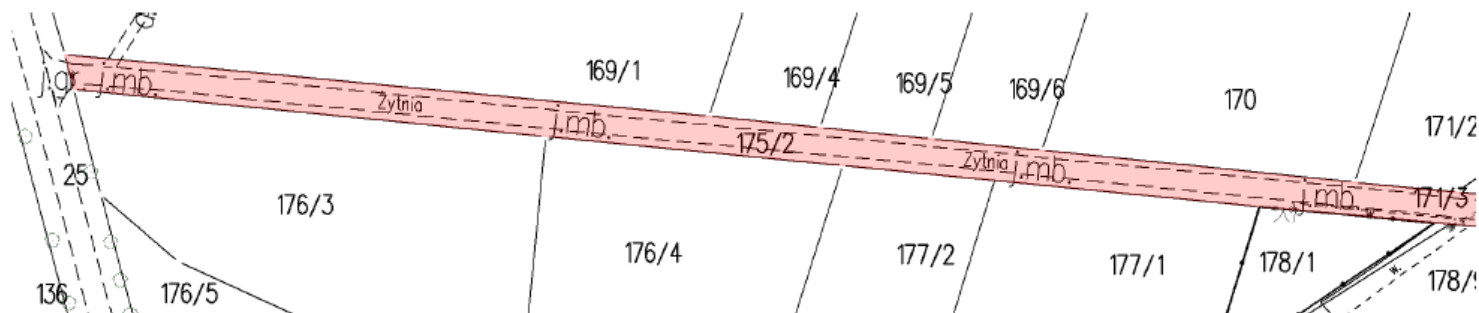

ul. Żytnia (część 2)

